

Waveguide is  
Making a Resurgence  
in 5G Antennas p24

Bandpass Filters:  
What's the Best Option  
for Your Design? p41

Perform Comms, Radar  
Modulation Classification with a  
Deep-Learning Network p48

# Microwaves & RF®

YOUR TRUSTED ENGINEERING RESOURCE FOR OVER 50 YEARS

FEBRUARY 2020 mwr.com

## THE STATE OF

# 5G

The future looks  
bright, but what's  
being done to  
solve the ongoing  
capacity issues? p17

**Largest  
In-Stock Selection,  
Same-Day Shipping**

[Pasternack.com](http://Pasternack.com)

**PE PASTERNAK**  
an INFINIT® brand

\$10.00

# PRECISION COMPONENTS. PRECISION MEASUREMENTS.



Make complex measurements  
where limited solutions exist

## Anritsu's metrology-grade coaxial W1 components delivers precision performance and repeatability.

Unlike solutions from other vendors whose products are based on banded waveguide frequencies, Anritsu's family of millimeter-wave components provide frequency range from DC to 110 GHz and improve repeatability of measurements by removing the need for a waveguide interface.

Be a Leader - Discover how you can get better measurement confidence with Anritsu. View our complete line of millimeter-wave testing solutions at [www.anritsu.com/test-measurement](http://www.anritsu.com/test-measurement)

### KEY FEATURES



Broadband solution  
from DC to 110 GHz



Coaxial solution removes  
complexity and increases  
ease-of-use



W1 connectors intended for  
broadband scalability and mode  
free performance to 110 GHz



Metrology-grade solution provides  
optimal connector tolerances and  
design for highest performance

**Anritsu**

[www.anritsu.com](http://www.anritsu.com)



# Broadband GaAs MMIC's

AMCOM's **AM06013033WM-XX-R** is a broadband GaAs MMIC which operates between 6 and 13 GHz with 28 dB gain and 33 dBm output power. This MMIC is available in both bare die form (AM06013033WM-00-R) and packaged form (AM06013033WM-EM-R). The EM package is a ceramic package with a flange and straight RF and DC leads for drop-in assembly. The MMIC input and output are internally matched to 50 Ohms.

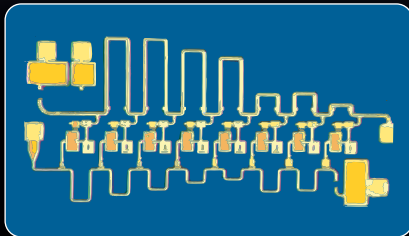
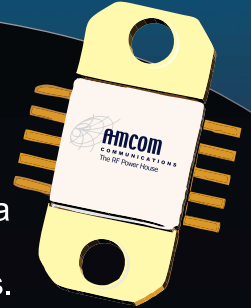

## FEATURES

- Ultra-Broadband from DC to 20 GHz
- Saturated output power  $P_{sat}$  is 26 dBm
- Gain, 13.5 dB
- Input & output matched to 50 Ohms

AMCOM's **AM00020026WM-00-R** is a broadband GaAs MMIC Distributed Power Amplifier die which operates between DC and 20 GHz. This amplifier has 13.5 dB gain, and 26 dBm output power. The chip input and output are internally matched to 50 Ohms.

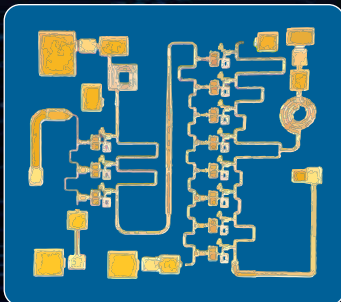

## FEATURES

- Ultra-Broadband from 2 to 18 GHz
- Saturated output power  $P_{sat}$  is 26 dBm
- Gain, 23.5 dB
- Input & output matched to 50 Ohms

AMCOM's **AM02018026WM-00-R** is a broadband GaAs MMIC Distributed Power Amplifier die which operates between 2 and 18 GHz. This amplifier has 23.5 dB gain, and 26 dBm output power. The chip input and output are internally matched to 50 Ohms.

[www.amcomusa.com](http://www.amcomusa.com)

401 Professional Drive, Gaithersburg, MD. 20879  
Phone 301.353.8400 - [info@amcomusa.com](mailto:info@amcomusa.com)

cādence®

welcomes



# TOMORROW'S DESIGNS REQUIRE **SMARTER** SOFTWARE TODAY



**AWR**

AWR Design Environment software provides a seamless platform for developing next-generation wireless electronics and communications systems, from concept to product. Its powerful interface, integrated system, circuit, and electromagnetic simulation technologies, and design flow automation ensures your design success.

Visit [awr.com/smarterdesign](http://awr.com/smarterdesign) to learn more.

# IN THIS ISSUE

## FEATURES

- 17**     **Surveying the Status of 5G Technology**  
 Wireless carriers around the world are accelerating the buildup of 5G network infrastructure with major investments in spectrum, base stations, microcells, and hotspots.
  
- 22**     **Metamaterials Boost MRI Performance without Increased Magnetic Field**  
 Using an array of helical coils formed on a metamaterial core, a research team greatly improved the performance of an MRI machine without having to ramp up magnetic field intensity.
  
- 24**     **Waveguide Makes a Comeback in 5G—for Antennas**  
 Waveguide is taking on a new role in the next generation of wireless systems in small form factors considered inconceivable before.
  
- 29**     **Delivering 5G Devices to Market Will Bank on OTA Testing**  
 As 5G begins to leverage high-frequency mmWave bands, engineers that used to work at RF frequencies will once again need to sharpen their skill sets and adopt new design and testing techniques.
  
- 41**     **Stuck in the Middle: How to Choose Your Next Bandpass Filter**  
 The seemingly ubiquitous bandpass filter plays an important role in reducing noise and radiation in an array of applications. Here's a synopsis of the most popular options available.
  
- 45**     **From Saving Lives to Leveraging IoT—This Smart Hospital Does It All**  
 The availability of granular real-time data allows this hospital team to gauge how its energy-reduction programs are performing, helping ensure that targets are met on time.
  
- 48**     **Identify Modulation for Communications and Radar Using Deep Learning**  
 Signals can be extracted automatically using available frameworks and tools, or via alternate approaches, which can then be used to perform modulation classification with a deep-learning network.

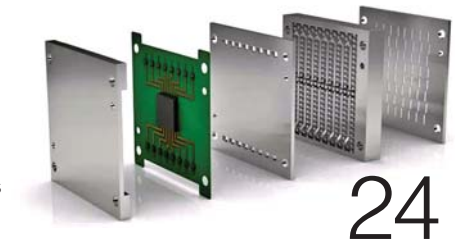

## NEWS & COLUMNS

- 5**     **EDITORIAL**  
 Veteran Editor Joins *Microwaves & RF*
  
- 8**     **ON MWRF.COM**
  
- 10**    **NEWS**
  
- 55**    **NEW PRODUCTS**
  
- 56**    **ADVERTISERS INDEX**

## PRODUCTS & TECHNOLOGY

- 35**    11 Myths About OpenVPX and the SOSA Initiative
  
- 37**    Expedite 5G MIMO Rollouts with Programmable RF Test Devices
  
- 40**    What's the Difference Between RMS and Peak Watts?

JOIN US ONLINE

---

 follow us @MicrowavesRF

 become a fan at facebook.com/microwavesRF

## Transient Immunity Testers from AVTECH

The Avtech AVRQ series of high-voltage, high-speed pulse generators is ideal for testing the common-mode transient immunity (CMTI) of next-generation optocouplers, isolated gate drivers, and other semiconductors.

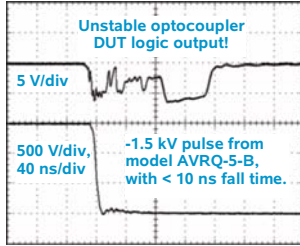

- ◆ Kilovolt amplitudes ( $\pm 1$ ,  $\pm 1.5$ ,  $-2$  kV)
- ◆ Transition times down to 10 ns, dV/dt rates up to 120 kV/us
- ◆ Switchable daughterboards to handle a variety of DUT package styles
- ◆ GPIB, RS-232 ports standard
- ◆ Ethernet / VXI optional



Nanosecond Electronics  
Since 1975

Pricing, manuals, datasheets and test results at:  
<http://www.avtechpulse.com/semiconductor>

## 30, 50 and 100 Volt Lab Pulsers



Avtech offers an extensive series of user-friendly 30, 50 & 100 Volt general-purpose lab pulsers. We can provide an alternative for the discontinued Agilent 8114A or HP214!

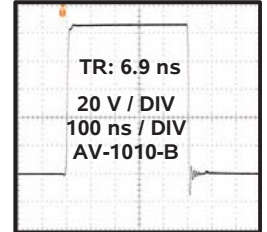

- Model AV-1015-B: 50 Volts, 10 MHz
- Model AV-1010-B: 100 Volts, 1 MHz, 25 ns to 10 ms, 10 ns rise time
- Model AV-1011B1-B: 100 Volts, 2 ns rise time
- Model AV-1011B3-B: 30 Volts, 0.5 ns rise time

Variable baseline and burst mode options and output currents to 8 Amps with accessory transformers.



Nanosecond Electronics  
Since 1975

Pricing, manuals, datasheets and test results at:  
<http://www.avtechpulse.com/general>

## Nanosecond Laser Diode Drivers With Butterfly Diode Sockets

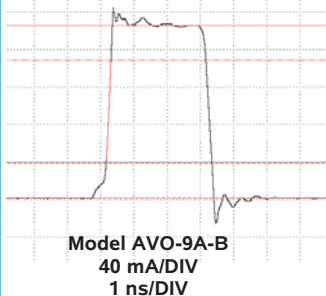
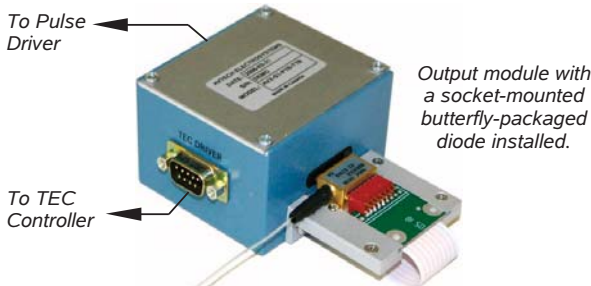

Each of the 19 models in the Avtech AVO-9 series of pulsed laser diode drivers includes a replaceable output module with an ultra-high-speed socket suitable for use with sub-nanosecond rise time pulses. Models with maximum currents of 0.1A to 10A are available with pulse widths from 400 ps to 1 us. GPIB, RS-232, and Ethernet control available.



Nanosecond Electronics  
Since 1975

Pricing, manuals, datasheets and test results at:  
<http://www.avtechpulse.com/laser>

## 2 to 200 Amp Current Pulsers



Avtech has pioneered the design of user-friendly 2 to 200 Amp constant current pulsers. We offer over 35 models in five series for laser diode, air bag, squib, fuse and other applications. The basic specifications are as follows:

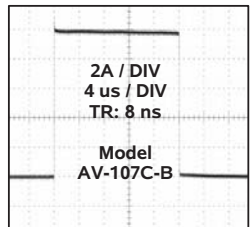

Series	I, V	PW	TR
AV-107	2 - 20 A, 60 V	0.2 - 200 us	10 - 30 ns
AV-106	5 - 100 A, 100 V	0.5 us - 1 ms	50 ns - 1 us
AV-108	12.5 - 200 A, 100V	2 us - 1 ms	5 - 15 us
AV-109	10 - 100 A, 5 V	10 us - 1 s	10 us
AV-156	2 - 30 A, 30 V	1 us - 100 ms	0.2 - 50 us

Avtech has a long history of producing one-of-a-kind custom units.



Nanosecond Electronics  
Since 1975

Pricing, manuals, datasheets and test results at:  
<http://www.avtechpulse.com/current>



## Editorial

WILLIAM WONG | Senior Technology Editor

# Veteran Editor Joins *Microwaves & RF*

David Maliniak, former technology editor with *Electronic Design*, joins *Microwaves & RF* as the new editor.

Chris DeMartino directed *Microwaves & RF* for many years and he left some big shoes to fill. Well, I am happy to say that we have found someone to step in as Editor of *Microwaves & RF* and he may be familiar to many of you who also read our sister publication, *Electronic Design*.

I would like to welcome David Maliniak (see figure below) back to our group as editor of *Microwaves & RF*. David will be helming the editorial page of the print edition and writing articles for the magazine and website. He will be managing contributed articles as well, so keep those coming.

David has had a long career in the B2B electronics-industry media as both generalist and specialist. He started as Components Editor for *EE Product News*, a product tabloid that was once part of our group, eventually becoming Editor in Chief. *EE Product News* coverage was later merged with *Electronic Design*.

At *Electronic Design*, David covered EDA as well as test and measurement as a Technology Editor, developing deep insight into those complex areas of technology. I worked with David for many years at *Electronic Design* until he moved into technical marketing communications for Teledyne LeCroy.

David earned a B.A. in journalism at New York University, but has garnered extensive technical background covering everything from components to advanced EDA tools, wireless technology, and test-and-measurement products like oscilloscopes, logic analyzers, and other test equipment. He brings a breadth of experience in covering technology that's central to *Microwaves & RF*.

You will be seeing David at various technology trade shows and technical conferences to bring you coverage of the latest trends and new products. You can also contact him if you want to contribute articles to *Microwaves & RF*. [info@herotek.com](mailto:info@herotek.com)

## Microwaves & RF

David Maliniak



## SURFACE MOUNT/DROP IN Comb Generators from HEROTEK

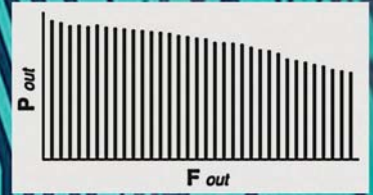

**Herotek, Your Source for the Most Comprehensive Line of Comb Generators**

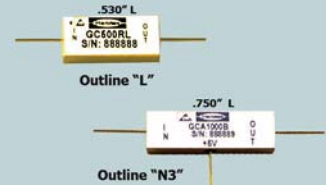

Specifications @ +25 °C

MODEL	INPUT FREQ. (MHz)	INPUT POWER (dBm)	OUTPUT FREQ. (GHz)	OUTLINE
GC100 RL	100	+27	18	L
GC200 RL	200	+27	18	L
GC250 RL	250	+27	18	L
GC500 RL	500	+27	18	L
GC1000 RL	1000	+27	18	L
GC0526 RL	500	+27	26	L
GC1026 RL	1000	+27	26	L
GC1526 RL	1500	+27	26	L
GC2026 RL	2000	+27	26	L
GCA250A N3	250	0	18	N3
GCA250B N3		+10		
GCA500A N3	500	0	18	N3
GCA500B N3		+10		
GCA1000A N3	1000	0	18	N3
GCA1000B N3		+10		
GCA0526A N3	500	0	26	N3
GCA0526B N3		+10		
GCA1026A N3	1000	0	26	N3
GCA1026B N3		+10		
GCA1526A N3	1500	0	26	N3
GCA1526B N3		+10		
GCA2026A N3	2000	0	26	N3
GCA2026B N3		+10		

Note: Other input frequencies from 10 MHz to 10 GHz are available.



The Microwave Products Source



**Herotek, Inc.**  
155 Baytech Drive  
San Jose, CA 95134  
Tel: (408) 941-8399  
Fax: (408) 941-8388

Made in U.S.A.



ISO 9001-2008 Certified

Website: [www.herotek.com](http://www.herotek.com) email: [info@herotek.com](mailto:info@herotek.com)

Looking for just  
the right part,  
at just the right price...

Connect with  
over 200  
distributors  
on the NEW  
SourceESB!



Find electronic parts fast -  
from the only database  
that verifies  
part authorization.

Parts ▾ Enter part... Enter List 🔍



## Part Lists Tool

- ✓ Send multi-part RFQs
- ✓ Save your part lists to work on later
- ✓ Filter by authorized distributor

[www.SourceESB.com](http://www.SourceESB.com)

### EDITORIAL

SENIOR CONTENT DIRECTOR: **BILL WONG** bwong@endeavorb2b.com  
SENIOR EDITOR: **DAVID MALINAIAK** majorworks9@gmail.com  
SENIOR STAFF WRITER: **JAMES MORRA** jmorra@endeavorb2b.com  
TECHNICAL EDITOR: **JACK BROWNE** jack.browne@citadeleng.com  
ASSOCIATE EDITOR/COMMUNITY MANAGER: **ROGER ENGELKE** engelke@endeavorb2b.com

### ART DEPARTMENT

GROUP DESIGN DIRECTOR: **ANTHONY VITOLO** tvitolo@endeavorb2b.com  
CONTENT DESIGN SPECIALIST: **JOCELYN HARTZOG** jhartzog@endeavorb2b.com

### PRODUCTION

GROUP PRODUCTION MANAGER: **GREG ARAUJO** garaujo@endeavorb2b.com

### AUDIENCE MARKETING

USER MARKETING MANAGER: **DEBBIE BRADY** dbrady@endeavorb2b.com

### FREE SUBSCRIPTION / STATUS OF SUBSCRIPTION / ADDRESS CHANGE/ MISSING BACK ISSUES:

OMEDA **T** | 847.559.7598 **TOLL FREE** | 877.382.9187 **FAX** | 847.564.9453

### SALES & MARKETING

#### REGIONAL SALES REPRESENTATIVES:

AZ, NM, TX: **GREGORY MONTGOMERY** **T** | 480.254.5540 gmontgomery@endeavorb2b.com  
AK, NORTHERN CA, NV, OR, WA, WESTERN CANADA: **STUART BOWEN** **T** | 425.681.4395 sbowen@endeavorb2b.com  
AL, AR, SOUTHERN CA, CO, FL, GA, HI, IA, ID, IL, IN, KS, KY, LA, MI, MN, MO, MS, MT, NC, ND, NE, OH, OK, SC, SD, TN, UT, VA, WI, WV, WY,  
CENTRAL CANADA: **JAMIE ALLEN** **T** | 415.608.1959 **F** | 913.514.3667 jallen@endeavorb2b.com  
CT, DE, MA, MD, ME, NH, NJ, NY, PA, RI, VT, EASTERN CANADA:  
**ELIZABETH ELDRIDGE** **T** | 917.789.3012 eeldridge@endeavorb2b.com

#### INTERNATIONAL SALES:

GERMANY, AUSTRIA, SWITZERLAND: **CHRISTIAN HOELSCHER** **T** | 011.49.89.95002778 christian.hoelscher@hudsonmedia.com

BELGIUM, NETHERLANDS, LUXEMBURG, UNITED KINGDOM, SCANDINAVIA, FRANCE, SPAIN, PORTUGAL:

**LARA PHELPS** lara.phelps@hudsonmedia.co.uk

ITALY: **DIEGO CASIRAGHI** diego@casiraghi-adv.com

PAN-ASIA: **HELEN LAI** **T** | 886 2-2727 7799 helen@twoway-com.com

PAN-ASIA: **CHARLES LIU** **T** | 886 2-2727 7799 liu@twoway-com.com

REPRINTS: **WRIGHT'S MEDIA** **T** | 877.652.5295

LIST RENTALS/ SMARTREACH CLIENT SERVICES MANAGER: **MARY RALICKI** **T** | 212.204.4284 mralicki@endeavorb2b.com

### DIGITAL

SENIOR DIGITAL INNOVATION & STRATEGY DIRECTOR: **RYAN MALEC** rmalec@endeavorb2b.com

### DESIGN ENGINEERING & SOURCING GROUP

VICE PRESIDENT, DESIGN & ENGINEERING: **TRACY SMITH** **T** | 913.967.1324 **F** | 913.514.6881 tsmith@endeavorb2b.com

VICE PRESIDENT OF MARKETING SOLUTIONS: **JACQUIE NIEMIEC** jniemiec@endeavorb2b.com

### ENDEAVOR BUSINESS MEDIA, LLC

331 54th Ave N., Nashville, TN 37209 USA | [www.endeavorbusinessmedia.com](http://www.endeavorbusinessmedia.com)



CEO: **CHRIS FERRELL**

COO: **PATRICK RAINS**

CMO: **JUNE GRIFFIN**

VP, FINANCE: **JESSICA KLUG**

VP, PRODUCTION OPERATIONS: **CURT PORDES**

EVP, GROUP PUBLISHER – DESIGN & ENGINEERING, ENERGY, BUILDINGS & CONSTRUCTION: **REGGIE LAWRENCE**

CHIEF ADMINISTRATIVE AND LEGAL OFFICER: **TRACY KANE**

CRO: **SCOTT BIEDA**

CTO: **ERIC KAMMERZELT**

VP, ACCOUNTING: **ANGELA MITCHELL**

VP, DIGITAL BUSINESS DEVELOPMENT: **MONIQUE LEIJA**

EVP, SPECIAL PROJECTS: **KRISTINE RUSSELL**

Electronic Design | Machine Design | Microwaves & RF | Source ESB | Hydraulics & Pneumatics |

Global Purchasing | Distribution Resource | Power Electronics | Defense Electronics



# RF Amplifiers and Sub-Assemblies for Every Application

Delivery from Stock to 2 Weeks ARO from the catalog or built to your specifications!

- Competitive Pricing & Fast Delivery
- Military Reliability & Qualification
- Various Options: Temperature Compensation, Input Limiter Protection, Detectors/TTL & More
- Unconditionally Stable (100% tested)

ISO 9001:2000  
and AS9100B  
CERTIFIED



## OCTAVE BAND LOW NOISE AMPLIFIERS

Model No.	Freq (GHz)	Gain (dB) MIN	Noise Figure (dB)	Power-out @ P1-dB	3rd Order ICP	VSWR
CA01-2110	0.5-1.0	28	1.0 MAX, 0.7 TYP	+10 MIN	+20 dBm	2.0:1
CA12-2110	1.0-2.0	30	1.0 MAX, 0.7 TYP	+10 MIN	+20 dBm	2.0:1
CA24-2111	2.0-4.0	29	1.1 MAX, 0.95 TYP	+10 MIN	+20 dBm	2.0:1
CA48-2111	4.0-8.0	29	1.3 MAX, 1.0 TYP	+10 MIN	+20 dBm	2.0:1
CA812-3111	8.0-12.0	27	1.6 MAX, 1.4 TYP	+10 MIN	+20 dBm	2.0:1
CA1218-4111	12.0-18.0	25	1.9 MAX, 1.7 TYP	+10 MIN	+20 dBm	2.0:1
CA1826-2110	18.0-26.5	32	3.0 MAX, 2.5 TYP	+10 MIN	+20 dBm	2.0:1

## NARROW BAND LOW NOISE AND MEDIUM POWER AMPLIFIERS

Model No.	Freq (GHz)	Gain (dB) MIN	Noise Figure (dB)	Power-out @ P1-dB	3rd Order ICP	VSWR
CA01-2111	0.4 - 0.5	28	0.6 MAX, 0.4 TYP	+10 MIN	+20 dBm	2.0:1
CA01-2113	0.8 - 1.0	28	0.6 MAX, 0.4 TYP	+10 MIN	+20 dBm	2.0:1
CA12-3117	1.2 - 1.6	25	0.6 MAX, 0.4 TYP	+10 MIN	+20 dBm	2.0:1
CA23-3111	2.2 - 2.4	30	0.6 MAX, 0.45 TYP	+10 MIN	+20 dBm	2.0:1
CA23-3116	2.7 - 2.9	29	0.7 MAX, 0.5 TYP	+10 MIN	+20 dBm	2.0:1
CA34-2110	3.7 - 4.2	28	1.0 MAX, 0.5 TYP	+10 MIN	+20 dBm	2.0:1
CA56-3110	5.4 - 5.9	40	1.0 MAX, 0.5 TYP	+10 MIN	+20 dBm	2.0:1
CA78-4110	7.25 - 7.75	32	1.2 MAX, 1.0 TYP	+10 MIN	+20 dBm	2.0:1
CA910-3110	9.0 - 10.6	25	1.4 MAX, 1.2 TYP	+10 MIN	+20 dBm	2.0:1
CA1315-3110	13.75 - 15.4	25	1.6 MAX, 1.4 TYP	+10 MIN	+20 dBm	2.0:1
CA12-3114	1.35 - 1.85	30	4.0 MAX, 3.0 TYP	+33 MIN	+41 dBm	2.0:1
CA34-6116	3.1 - 3.5	40	4.5 MAX, 3.5 TYP	+35 MIN	+43 dBm	2.0:1
CA56-5114	5.9 - 6.4	30	5.0 MAX, 4.0 TYP	+30 MIN	+40 dBm	2.0:1
CA812-6115	8.0 - 12.0	30	4.5 MAX, 3.5 TYP	+30 MIN	+40 dBm	2.0:1
CA812-6116	8.0 - 12.0	30	5.0 MAX, 4.0 TYP	+33 MIN	+41 dBm	2.0:1
CA1213-7110	12.2 - 13.25	28	6.0 MAX, 5.5 TYP	+33 MIN	+42 dBm	2.0:1
CA1415-7110	14.0 - 15.0	30	5.0 MAX, 4.0 TYP	+30 MIN	+40 dBm	2.0:1
CA1722-4110	17.0 - 22.0	25	3.5 MAX, 2.8 TYP	+21 MIN	+31 dBm	2.0:1

## ULTRA-BROADBAND & MULTI-OCTAVE BAND AMPLIFIERS

Model No.	Freq (GHz)	Gain (dB) MIN	Noise Figure (dB)	Power-out @ P1-dB	3rd Order ICP	VSWR
CA0102-3111	0.1-2.0	28	1.6 Max, 1.2 TYP	+10 MIN	+20 dBm	2.0:1
CA0106-3111	0.1-6.0	28	1.9 Max, 1.5 TYP	+10 MIN	+20 dBm	2.0:1
CA0108-3110	0.1-8.0	26	2.2 Max, 1.8 TYP	+10 MIN	+20 dBm	2.0:1
CA0108-4112	0.1-8.0	32	3.0 MAX, 1.8 TYP	+22 MIN	+32 dBm	2.0:1
CA02-3112	0.5-2.0	36	4.5 MAX, 2.5 TYP	+30 MIN	+40 dBm	2.0:1
CA26-3110	2.0-6.0	26	2.0 MAX, 1.5 TYP	+10 MIN	+20 dBm	2.0:1
CA26-4114	2.0-6.0	22	5.0 MAX, 3.5 TYP	+30 MIN	+40 dBm	2.0:1
CA618-4112	6.0-18.0	25	5.0 MAX, 3.5 TYP	+23 MIN	+33 dBm	2.0:1
CA618-6114	6.0-18.0	35	5.0 MAX, 3.5 TYP	+30 MIN	+40 dBm	2.0:1
CA218-4116	2.0-18.0	30	3.5 MAX, 2.8 TYP	+10 MIN	+20 dBm	2.0:1
CA218-4110	2.0-18.0	30	5.0 MAX, 3.5 TYP	+20 MIN	+30 dBm	2.0:1
CA218-4112	2.0-18.0	29	5.0 MAX, 3.5 TYP	+24 MIN	+34 dBm	2.0:1

## LIMITING AMPLIFIERS

Model No.	Freq (GHz)	Input Dynamic Range	Output Power Range Psat	Power Flatness dB	VSWR
CLA24-4001	2.0 - 4.0	-28 to +10 dBm	+7 to +11 dBm	+/- 1.5 MAX	2.0:1
CLA26-8001	2.0 - 6.0	-50 to +20 dBm	+14 to +18 dBm	+/- 1.5 MAX	2.0:1
CLA712-5001	7.0 - 12.4	-21 to +10 dBm	+14 to +19 dBm	+/- 1.5 MAX	2.0:1
CLA618-1201	6.0 - 18.0	-50 to +20 dBm	+14 to +19 dBm	+/- 1.5 MAX	2.0:1

## AMPLIFIERS WITH INTEGRATED GAIN ATTENUATION

Model No.	Freq (GHz)	Gain (dB) MIN	Noise Figure (dB)	Power-out @ P1-dB	Gain Attenuation Range	VSWR
CA001-2511A	0.025-0.150	21	5.0 MAX, 3.5 TYP	+12 MIN	30 dB MIN	2.0:1
CA05-3110A	0.5-5.5	23	2.5 MAX, 1.5 TYP	+18 MIN	20 dB MIN	2.0:1
CA56-3110A	5.85-6.425	28	2.5 MAX, 1.5 TYP	+16 MIN	22 dB MIN	1.8:1
CA612-4110A	6.0-12.0	24	2.5 MAX, 1.5 TYP	+12 MIN	15 dB MIN	1.9:1
CA1315-4110A	13.75-15.4	25	2.2 MAX, 1.6 TYP	+16 MIN	20 dB MIN	1.8:1
CA1518-4110A	15.0-18.0	30	3.0 MAX, 2.0 TYP	+18 MIN	20 dB MIN	1.85:1

## LOW FREQUENCY AMPLIFIERS

Model No.	Freq (GHz)	Gain (dB) MIN	Noise Figure (dB)	Power-out @ P1-dB	3rd Order ICP	VSWR
CA001-2110	0.01-0.10	18	4.0 MAX, 2.2 TYP	+10 MIN	+20 dBm	2.0:1
CA001-2211	0.04-0.15	24	3.5 MAX, 2.2 TYP	+13 MIN	+23 dBm	2.0:1
CA001-2215	0.04-0.15	23	4.0 MAX, 2.2 TYP	+23 MIN	+33 dBm	2.0:1
CA001-3113	0.01-1.0	28	4.0 MAX, 2.8 TYP	+17 MIN	+27 dBm	2.0:1
CA002-3114	0.01-2.0	27	4.0 MAX, 2.8 TYP	+20 MIN	+30 dBm	2.0:1
CA003-3116	0.01-3.0	18	4.0 MAX, 2.8 TYP	+25 MIN	+35 dBm	2.0:1
CA004-3112	0.01-4.0	32	4.0 MAX, 2.8 TYP	+15 MIN	+25 dBm	2.0:1

CIAO Wireless can easily modify any of its standard models to meet your "exact" requirements at the Catalog Pricing.

Visit our web site at [www.ciaowireless.com](http://www.ciaowireless.com) for our complete product offering.

Ciao Wireless, Inc. 4000 Via Pescador, Camarillo, CA 93012

Tel (805) 389-3224 Fax (805) 389-3629 sales@ciaowireless.com

# ON MICROWAVES&RF.COM

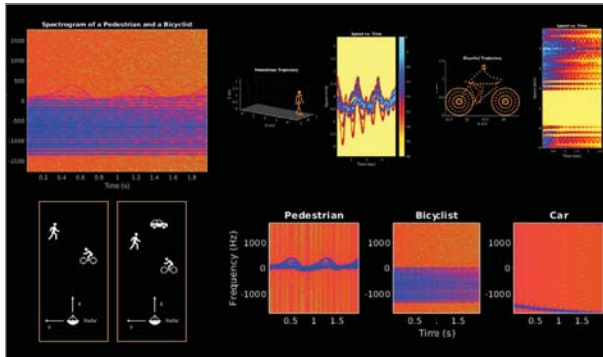

## Classifying Radar Micro-Doppler Signatures

This “Algorithms to Antenna” blog reveals how to classify pedestrians and bicyclists based on their micro-Doppler characteristics using a deep-learning network and time-frequency analysis.

<https://www.mwrf.com/technologies/systems/article/21120548/algorithms-to-antenna-classifying-radar-microdoppler-signatures>



## 5G: How Much is Real vs. Marketing?

Is 5G ready for prime time? Breaking down the marketing hype versus what’s really going on in the industry.

<https://www.mwrf.com/technologies/systems/article/21119441/5g-how-much-is-real-vs-marketing>



## A New Approach to Over-the-Air Production Test

Noise sources and peak power meters are the key ingredients in a novel over-the-air test methodology that’s faster and more cost-effective than current techniques.

<https://www.mwrf.com/technologies/test-measurement/article/21850054/a-new-approach-to-overtheir-production-test>

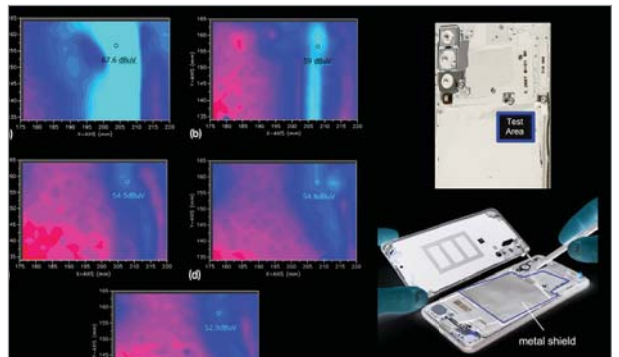

## EMI Suppression Shields: Understanding the Basics

With so many different magnetic materials to choose from, one must discern the frequencies and noise levels where EMI problems are prevalent and deduce how the materials’ parameters can impact noise suppression to comply with regulatory limits.

<https://www.mwrf.com/materials/article/21119915/emi-suppression-shields-understanding-the-basics>

join us online  

twitter.com/MicrowavesRF facebook.com/microwavesrf

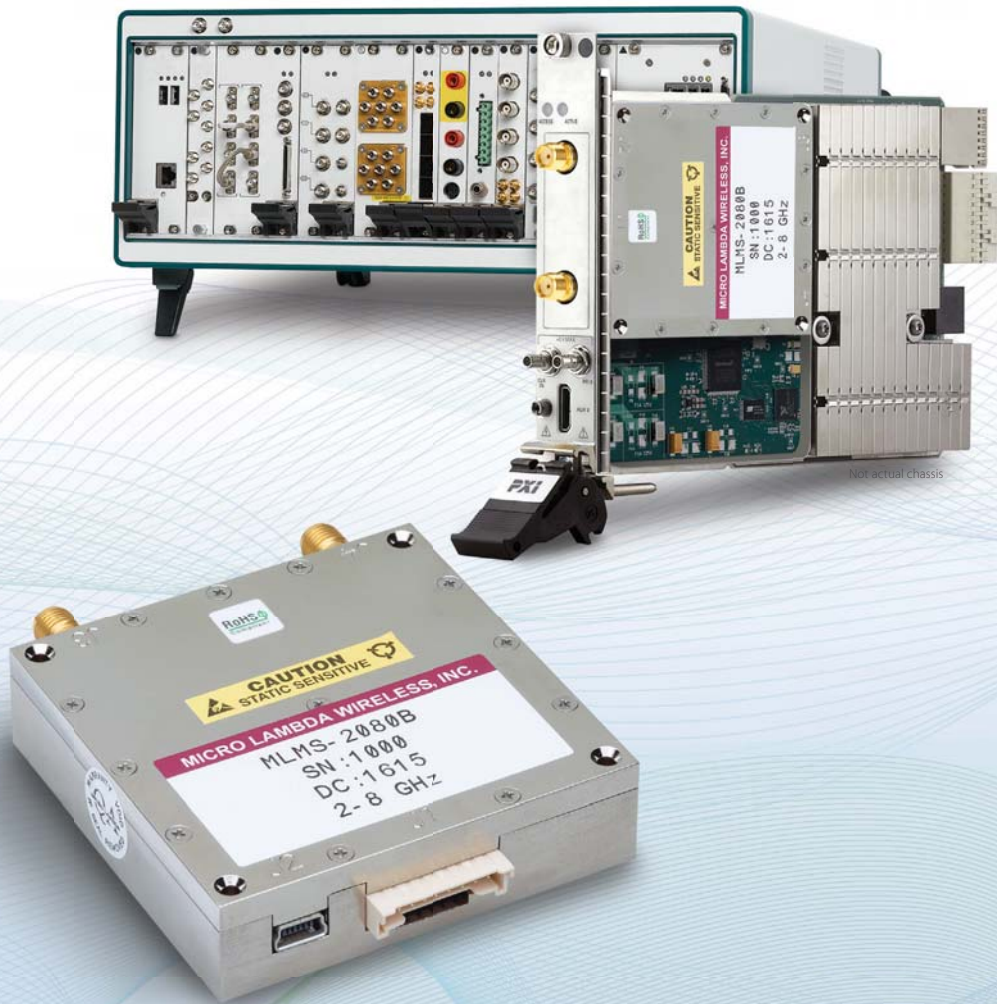

# Single Slot PXI Frequency Synthesizer

## **NEW!** MLMS-Series Frequency Synthesizers – 250 MHz to 16 GHz

The MLMS-Series Frequency Synthesizers from Micro Lambda Wireless, Inc. is a new smaller and lower cost frequency synthesizer designed to fit into a single slot PXI chassis. Dimensions measure 2.5" x 2.5" x .65" tall. Standard frequency models are available covering 250 MHz to 6 GHz, 2 to 8 GHz, 6 to 13 GHz and 8 to 16 GHz. Special customer defined frequency ranges within the entire frequency range are available on special order. Applications include Wide Band Receivers, Automated Test Systems, Telecom, Satcom, UAV's and Drones, as well as a variety of Military and Commercial Test applications.

For more information contact Micro Lambda Wireless.

[www.microlambdawireless.com](http://www.microlambdawireless.com)

*Micro Lambda is a ISO 9001:2015 Registered Company*



*"Look to the leader in YIG-Technology"*

# News

## Qualcomm Wades into Battleground WITH NEW WI-FI CHIPS FOR CARS

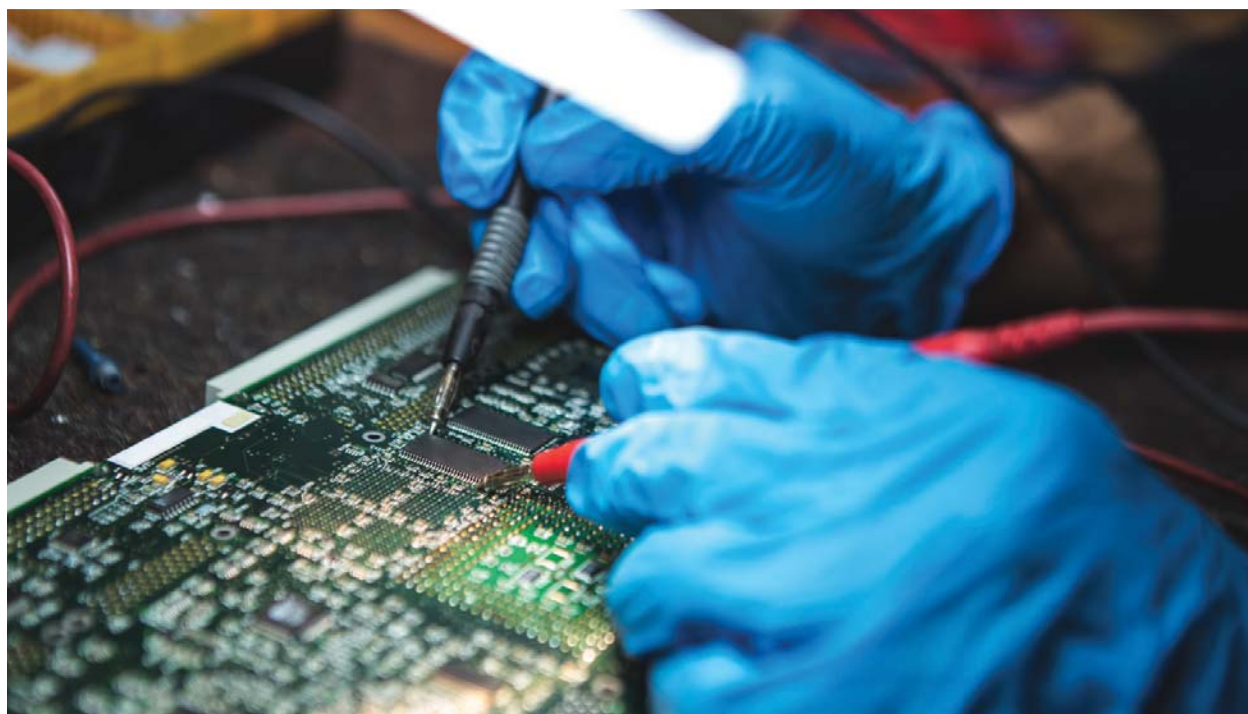

Qualcomm introduced its latest integrated chip for adding Bluetooth and Wi-Fi to mid-range cars at the recent Consumer Electronics Show, as the car of the future becomes one of the major battlegrounds in the global chip business. The new chip supports Wi-Fi 5 and the latest generation of Bluetooth 5 and expands Qualcomm's lineup of wireless connectivity products to "virtually all vehicle classes."

Qualcomm said the QCA6595AU is more advanced than current Wi-Fi 5 chips sold to car manufacturers and that it can offer data transfer speeds of up to 1 Gb/s. The chip can be used

to support 5-GHz Wi-Fi throughout the car while also connecting 2.4-GHz Wi-Fi and Bluetooth 5.1 devices to the digital dashboard, including voice and audio over wireless headphones and speakers. Qualcomm will start selling the new chip to car manufacturers in late 2020.

The chip is designed to shoot signals over both the 5-GHz and 2.4-GHz bands, offering faster data speeds so that drivers can connect smartphone apps or transfer video to the dashboard. The 28-nm networking chip, which can connect up to 32 Wi-Fi devices throughout the car, also supports Bluetooth 5.1 and

Qualcomm's aptX Adaptive technology for cleaner, crisper audio and voice. It can withstand temperatures ranging from  $-40$  to  $+85^{\circ}\text{C}$ .

It also complements the other Wi-Fi and Bluetooth chips it sells to car manufacturers. Last year, Qualcomm introduced its integrated Wi-Fi 6 chip for cars, the QCA6696, which can offer data transfers of up to 1.8 Gb/s. The chip should start shipping in cars in 2021, the company said. On the other end of the product line is the QCA6574AU, which can support data speeds of up to 870 Mb/s and uses the legacy Wi-Fi 5 and Bluetooth 5 standards.

# MMIC SPLITTER/COMBINERS

up to **43.5 GHz**



**THE WIDEST SURFACE MOUNT  
BANDWIDTHS IN THE INDUSTRY!**

- ▶ Power handling up to 2.5W
- ▶ Insertion loss, 1.1 dB typ.
- ▶ Isolation, 20 dB



[www.minicircuits.com](http://www.minicircuits.com) (718) 934-4500 [sales@minicircuits.com](mailto:sales@minicircuits.com)



596\_Rev A\_P

# Priority: Source High-Reliability RF Cables

- ☑ Reliability
- ☑ J-STD Soldering
- ☑ Test Reports
- ☑ Lot Traceability



Available for  
Same-Day Shipping!



## News

Qualcomm, one of the major designers of chips used in smartphones, has been trying to carve out more market share in cars since its \$44 billion bid for NXP Semiconductors fell through in 2018. The company has long been one of the top vendors of Wi-Fi, Bluetooth, and other chips used in the dashboard electronics as well as baseband modems that connect the car to the cloud over cellular networks.

On top of the new Wi-Fi and Bluetooth chip, Qualcomm introduced its Cloud-to-Car service at CES 2020, so that manufacturers can securely and safely upgrade the car's programming from the cloud. It rolled out blueprints for building short-range radio technol-

ogy into cars so that they can chat with each other and infrastructure like stop lights and road signs, alerting drivers to potential collisions and other dangers on the road ahead.

The cellular vehicle-to-everything (C-V2X) standard can be used to broadcast data on the car's location, speed, direction, and acceleration to other cars equipped with C-V2X. Drivers can be alerted when other cars are slamming on the brakes, running through red lights and stop signs, slowing down for construction, speeding around corners, or swerving on slippery road surfaces. The C-V2X standard delivers 360-degree coverage of the car's surroundings. ■

## BUILDING CUSTOM CHIPS Just Got Easier

**ZGLUE'S 2.5D CHIPLET** Smart Fabric platform (Fig. 1) builds chips out of chiplets that are connected with a silicon interposer layer, very similar to a chip-based printed circuit board. The chiplets are functional blocks like processors and peripherals typically found in a custom chip or in discrete components. A zGlue-based chip has the advantages of tight integration, small packaging, and power efficiency of an ASIC, but with signifi-

cantly less cost. This makes it practical for smaller runs as well as creating more customized solutions quickly.

ChipBuilder Pro (Fig. 2) was on display at last month's Consumer Electronics Show, where the product was a CES 2020 Innovation Awards Honoree. The visual zGlue Integrated Platform (ZIP) allows developers to select from 1500 chiplets to include in their designs. This includes chiplets like Cypress Semiconductor's

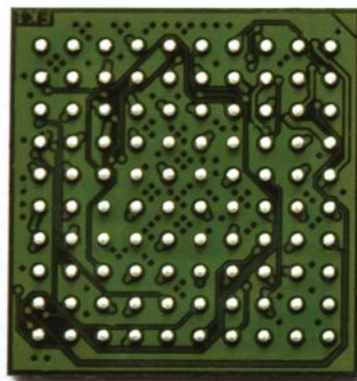

1. zGlue's Smart Fabric silicon interposer technology allows chiplets to be mounted within a chip to deliver compact, custom chips.

# *You Engineer the Future. We'll Supply the Components... Today!*

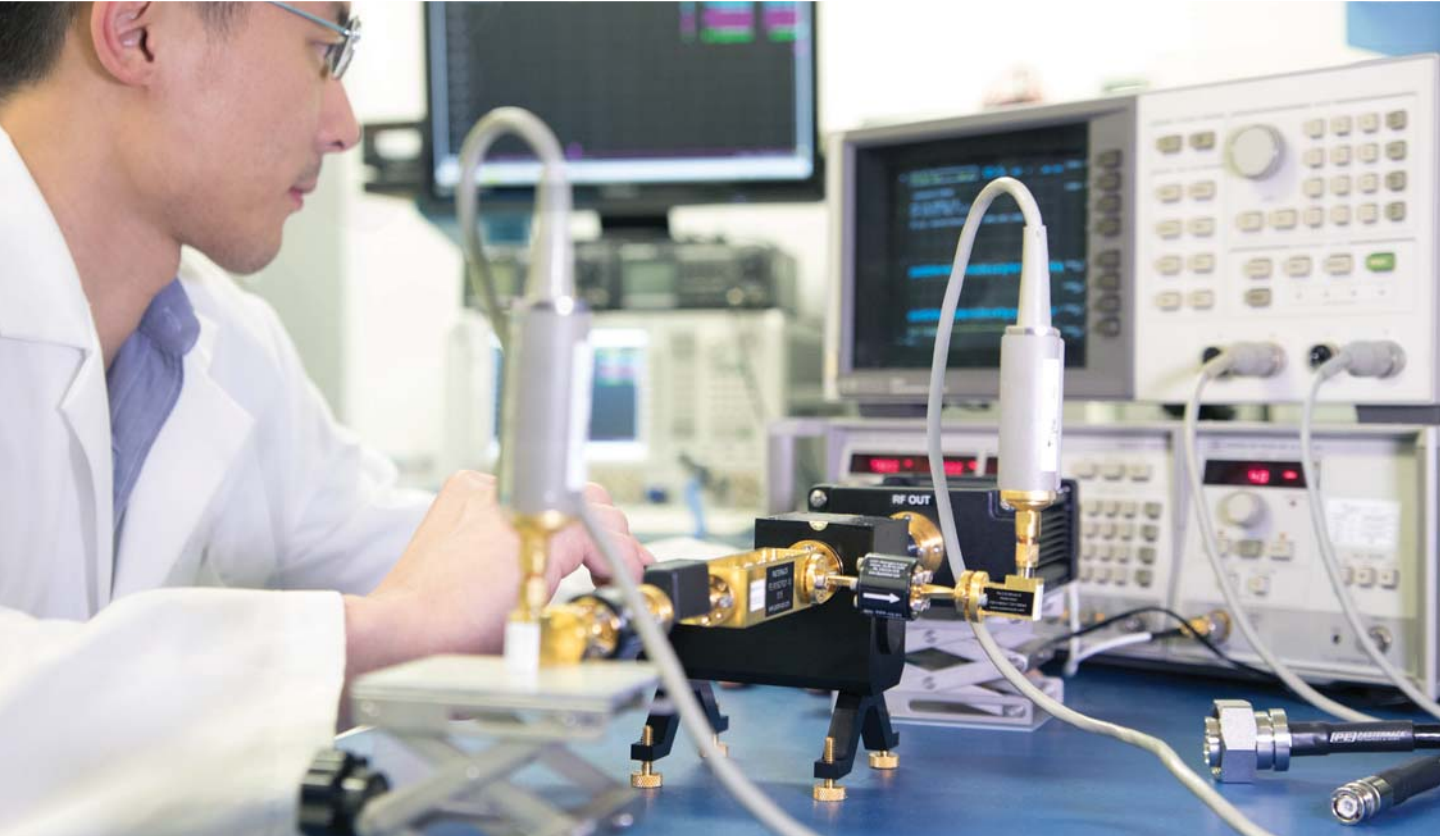

*Largest Selection ✓ Same-Day Shipping ✓ Expert Technical Support ✓*

Armed with the world's largest selection of in-stock, ready to ship RF components, and the brains to back them up, Pasternack Applications Engineers stand ready to troubleshoot your technical issues and think creatively to deliver solutions for all your RF project needs. Whether you've hit a design snag, you're looking for a hard to find part or simply need it by tomorrow, our Applications Engineers are at your service. Call or visit us at [pasternack.com](http://pasternack.com) to learn more.

866.727.8376  
[Pasternack.com](http://Pasternack.com)

**PE PASTERNAK®**  
an INFINIT® brand

PSoC and Wi-Fi chiplets. Custom chiplets can be added to the list by working with zGlue. The zGlue ChipletStore also has 60

Quickstart Templates. The software provides design and release management plus versioning support.

zGlue sells the ChipBuilder Pro and provides the ChipBuilder 3.0 Community Edition for free. ChipBuilder Pro has a yearly subscription price of \$25,000 that includes 10 chips of one new design every year. An additional 100 chips run \$25,000.

The yearly subscription includes 40 hours of engineering support as well as parasitic net extraction and system verification. Security features include IP protection and visibility into account activity. This approach also supports system reconfiguration during the hardware debug process. As a result, developers can fix bugs without the need for remanufacturing. ■

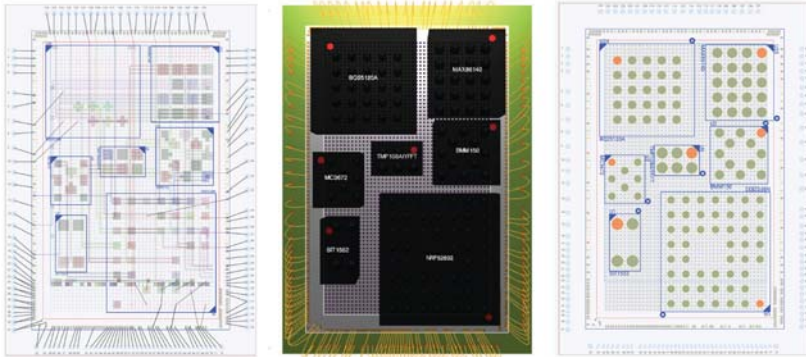

2. ChipBuilder Pro provides an easy-to-use, visual interface for designing with chiplets.

## E-FUSE FAMILY ADDS FEATURES, Functionality to Basic Fuse Role

**ELECTRONIC FUSES CAN** do much more than just provide basic overcurrent protection, as evidenced by the features and functions of the Toshiba TCKE8xx family.

The traditional thermally activated overcurrent-protection “sacrificial” fuse does one thing and does it well, which is both its strength and weakness. Electronic fuses (commonly referred to as e-fuses or efuses) are increasingly challenging these venerable fuses due to the flexibility and features they offer, providing performance and operational advantages across many applications.

Toshiba Electric has entered the e-fuse market with a family of six devices featuring highly accurate overcurrent limit, overvoltage protection, and overtemperature protection, in addition to short-circuit protection. Compared to polymeric positive temperature coefficient (PPTC) devices that are also resettable, they react much faster, can be reset directly via an external logic signal, and retain their low on-resistance even after multiple trip events.

The members of the TCKE8xx series come in three categories: no overvolt-

age  $V_{OVC}$  protection, 5 V ( $V_{OVC} = 6.04$  V), and 12 V ( $V_{OVC} = 15.1$  V); each category is offered in both auto-retry or latched options after a fault event. The status of the latch type is determined by application of an external signal, while the auto-retry is capable of re-enabling its output automatically. The fast-trip comparator can switch off the output typically within

150 ns, far faster than a fusible link and a better fit with the needs of sensitive electronics.

Functions available with these e-fuses include:

- *Quick short-circuit protection:* The ultra-high-speed short-circuit protection technique provides basic role.

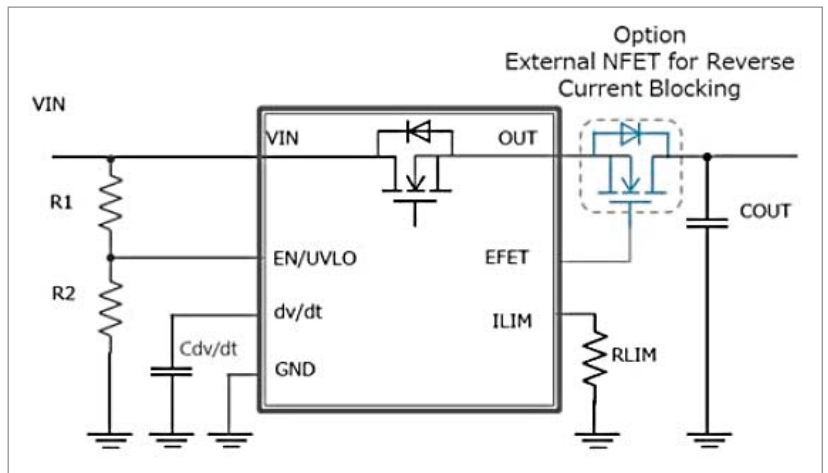

Beyond the many integrated functions of the Toshiba TCKE8xx series of e-fuses, they can implement reverse-current blocking protection with the addition of a suitable external MOSFET.



**Electronic fuses (commonly referred to as e-fuses or efuses) are increasingly challenging these venerable fuses due to the flexibility and features they offer, providing performance and operational advantages across many applications.**

- *High-precision overcurrent protection:* User-set via external resistors.
- *High-precision overvoltage clamp function:* Prevents excessive voltage from being applied to the load ICs by clamping the outputs for instantaneous voltage increases.
- *Ability to suppress inrush current:* An external capacitor can be added to reduce inrush current by setting a turn-on slew-rate at the output as desired.
- *Thermal shutdown function and recovery operation:* If a fault condition persists for a long time such that the IC temperature exceeds the set temperature, the IC goes to a standby state to shut off the output and prevent the output from being damaged by the thermal shutdown function.

Furthermore, an external N-channel MOSFET can be added for reverse-current blocking protection, often mandated in automotive and other applications (see figure on page 14).

These e-fuses are housed in 3.00- x 3.00-mm, 0.75-mm-high WSON10B packages, with typical  $R_{ON}$  of just 28 m $\Omega$  and an overcurrent limit accuracy of  $\pm 11\%$  over the  $-40$  to  $+85^{\circ}\text{C}$  range. Input voltages of 4.4 to 18.0 V are supported and output currents can be as high as 5.0 A. Their certification to IEC 62368-1 eases the path to certification testing and approval of the overall product. More information on the Toshiba Electric TCKE8xx series is available at <https://toshiba.semicon-storage.com/ap-en/product/linear/power-supply/efuse-ics.html>. ■

**KOAXIS.com**  
RF Cable Assemblies

## Semi-rigid Design Guide



**Quicker and more cost-effective assemblies are as easy as 1-2-3-4-5-6**

download the guide at [koaxis.com](http://koaxis.com)

while you're there...

**Build It** visually build a cable assembly  
**See It** get a specification instantly  
**Buy It** online using eCommerce



Made in the USA

+1 (610) 222-0154

# The Right RF Parts. Right Away.



**Available for Same-Day Shipping!**

We're RF On Demand, with over one million RF and microwave components in stock and ready to ship. You can count on us to stock the RF parts you need and reliably ship them when you need them. Add Fairview Microwave to your team and consider it done.

Fairviewmicrowave.com  
1.800.715.4396

 **Fairview Microwave™**  
an INFINITE brand

# Surveying the Status of 5G Technology

Wireless carriers around the world are accelerating the buildup of 5G network infrastructure with major investments in spectrum, base stations, microcells, and hotspots.



1. Aggressive infrastructure buildup in highly populated areas such as Beijing, China is making commercial 5G network service available. (Courtesy of Qualcomm)

**M**obile telecommunications carriers around the world have proclaimed 5G cellular wireless networks as the next major step in communications technology. They will do what cellular network generations before them could not, operating at frequencies and data rates never possible. They will serve billions of users worldwide (if not just in China) and provide the bandwidth required for a future filled with Internet of Things (IoT) devices for smart homes, smart factories, and smart cities, as well as the

near-zero-latency signals for autonomous vehicles on smart highways.

The future of 5G certainly looks bright but what about the present? The hyperbole about 5G New Radio (NR) networks and technology is enormous, but how close is it to becoming reality?

The primary need for 5G is additional wireless capacity: it will provide service for more cell phones and other wireless devices. The global demand for wireless devices and services continues to grow, eclipsing the capacities of the first four cellular generations. 5G will add capacity along with enhanced performance

in support of emerging applications powered by IoT devices. Its extended frequencies, bandwidths, and associated technologies are not meant to replace earlier cellular wireless network generations, such as 3G and 4G Long Term Evolution (LTE), but to work alongside them.

## FR1 AND FR2

While a great deal of the novelty associated with 5G networks is their reach into millimeter-wave (mmWave) frequencies, much of their operation will be performed within a frequency range that has come to be known as “FR1” for signals below 6 GHz, compared to higher-frequency signals (above 6 GHz) within a range known as “FR2.” More specifically, 5G networks are being designed for multilayer spectrum coverage, occupying licensed and unlicensed frequencies in three bands: low-band signals below 1 GHz, mid-band signals from 1 to 6 GHz, and high-band signals above 6 GHz at centimeter-wave (cmWave) and millimeter-wave (mmWave) frequencies.

Spectrum sharing will allow current wireless applications to coexist with low- and mid-band 5G network signals. As an example, China is experimenting with sharing frequency bands below 1 GHz (470 to 806 MHz) between existing broadcast television systems and emerging 5G multimedia mobile communica-

tions applications. Depending on 4G/5G network configurations, some shared spectrum may even involve uplinked versions of sub-1-GHz signals within crowded spectrum to take advantage of available wireless connections at higher frequencies, such as from 3.3 to 3.8 GHz in Europe.

gate the limits of higher-frequency 5G signals compared to earlier-generation cellular wireless networks (*Fig. 1*).

Many carriers have been aggressive in their claims of providing 5G network coverage, offering computerized coverage maps that indicate availability by frequency. The use cases for

the high path losses for cmWave and mmWave signals.

Both SA and NSA base stations will be important parts of 5G wireless networks. However, the two types of sites will have different functionality and capabilities requiring, for example, different test strategies to characterize 4G

---

**The adoption rate of 5G UE devices and services throughout the world is expected to quickly eclipse the rates at which customers took to 3G/4G devices and services.**

---

Frequency spectrum around the world is being allocated and, in some cases, auctioned for use by 5G carriers. The costs of licensing frequencies and bandwidth can vary widely by region, from the FCC's high-cost auctioning of frequencies according to its 5G Facilitate America's Superiority in 5G Technology (5G FAST) plan, to China's allocation of frequency bandwidth to its four government-owned 5G carriers.

Spectrum auctions by the FCC in the U.S. include FR1 bands of 3.100 to 3.550 GHz and 3.7 to 4.2 GHz, and FR2 bands of 27.50 to 28.35 GHz and 37 to 40 GHz. In contrast, in China, FR1 bands of 3.3 to 3.6 GHz, 4.4 to 4.5 GHz, and 4.80 to 4.99 GHz, and FR2 frequencies of 24.25 to 27.50 GHz and 37.00 to 43.50 GHz are being deployed. And in Japan, 5G will operate within FR1 bands of 3.6 to 4.2 GHz and 4.4 to 4.9 GHz, and FR2 frequencies of 27.50 to 28.28 GHz.

### PROPER INFRASTRUCTURE

Standards for 5G performance and protocols—established by organizations such as the IEEE and Third Generation Partnership Project (3GPP) and its TS 38.104 V15 specifications for 5G base stations—are essential for creating wireless networks and UE devices that will be compatible within a given operating region. In some locations, such as downtown Beijing, China, 5G network infrastructure has been deployed to investi-

5G coverage include enhanced mobile broadband (eMBB) applications like smartphones, massive machine-type communications (mMTC) such as in automated factories, and ultra-reliable low-latency communications (URLLC) such as in robotic surgery and vehicle-to-vehicle (V2V) communications for autonomous vehicles.

Infrastructure for 5G networks is being built “on top of” earlier cellular wireless generations, with 5G base stations being added whenever possible to 3G and 4G installations as non-standalone (NSA) 5G base stations. For voice and noncritical data applications, such installations can provide service by means of 3G or 4G networks, reserving 5G at its highest frequencies for low-latency, high-speed-data applications.

Transfer of data at high rates requires large amounts of contiguous bandwidth, which can be found with the lack of applications at 24 GHz and above. However, the higher path losses of those higher-frequency signals mean that they will not be as freely available in wireless networks without additional hardware and software assistance compared to lower-frequency signals.

To fill holes in the signal coverage between NSA base stations using mmWave signals, smaller 5G standalone (SA) base stations will be constructed. These will have much closer spacing between them because of

LTE equipment in NSA base stations compared to the higher-frequency transceivers in 5G NSA base stations. Due to the challenge of achieving coverage with mmWave signals, 5G networks will employ higher-frequency signals (and their support of high data rates) where they do the most good, such as in office buildings and heavily populated areas.

### INVESTING IN 5G

With its higher frequencies and technologies to support their use, investment in 5G wireless networks is not trivial—it's required the rapid growth of wireless users through 3G and 4G LTE networks. The adoption rate of 5G UE devices and services throughout the world is expected to quickly eclipse the rates at which customers took to 3G/4G devices and services.

South Korea, the first country to commercialize 5G wireless networks and UE devices, already has over 2.5 million 5G mobile broadband users. The South Korean government is very involved in the commercialization, subsidizing the sales of UE devices and cutting taxes on network infrastructure construction for service providers. That government feels 5G will have many vertical business branches that will boost its economy, such as autonomous driving in smart cities and digital wireless healthcare, and the technol-

ogy is well worth its involvement and investment.

Throughout the U.S., for example, 5G service providers such as AT&T, Sprint Nextel, T-Mobile, and Verizon have made major investments in their wireless networks, adding frequencies, capacity, and performance. AT&T, for example, quotes an investment of \$145 billion in its wireless network over the past five years, while T-Mobile has invested over \$30 billion in 5G network infrastructure that involves 25,000 new cell sites and towers. For all carriers and networks, performance will improve over time with the addition of bandwidth at higher frequencies. Some offer “offshoots” of full-featured 5G technology based on network availability, such as Verizon’s broadband internet Home 5G Service.

At present, 5G coverage in the U.S. is limited to select major cities and to performance levels that only begin to scratch the surface of 5G’s ultimate performance capabilities. As coverage extends to more rural areas, networks will evolve with functionality and services provided as needed. The networks support 5G smartphones from several major manufacturers, such as the Galaxy S10 5G phone from Samsung (Fig. 2). Within a 5G network, it’s capable of the fast upload/download data rates promised by 5G technology. Outside 5G coverage, it operates according to a network’s capabilities, serving largely as a fully functional 4G LTE smartphone.

Customers for 5G smartphones are getting an idea of the much higher costs of those devices compared to 4G phones—and this is with limited service. Service providers worldwide are in the process of constructing their 5G networks, currently offering very limited coverage mostly at lower frequencies and with some experimental or “pilot” cells operating at mmWave frequencies.

Very little is known about signal frequencies at 24 GHz and higher in actual

use and these test cases provide the means to discover the effects of real-world operating environments, such as rainfall attenuation, on mmWave signals. Signals at mmWave frequencies used in 5G systems for high-data-rate transmission and reception suffer much higher path loss than lower-frequency signals with longer wavelengths. They can be attenuated by a building, foliage, or even a user’s hand placed too close to the antenna array within a 5G smartphone.

Many service providers are learning a great deal from their users of these early 5G network sites, reporting positive results from the use of multiple-input, multiple-output (MIMO) antennas and active antenna systems (AAS) on extending coverage with mmWave signals. Antennas in  $4 \times 4$  MIMO configurations have been successfully applied in 4G LTE networks. Much larger antenna arrays are typically being used in 5G networks. These are often  $8 \times 8$ , 64-element active antenna arrays capable of controlling the phase and amplitude of each element to form a beam of directed energy between a base station and a user at mmWave frequencies.



**2. The Galaxy S10 smartphone from Samsung is one example of the many mobile, multiple-function UE devices being developed for 5G wireless networks. (Courtesy of Verizon)**



**3. Compact base stations like the Nokia Aircscale Base Station will add 5G coverage to areas already served by 3G and 4G LTE networks. These modular base stations make it possible to add 5G frequencies and spectrum as available to enhance performance and coverage. (Courtesy of Nokia)**

4. The advanced antennas and radio technologies used in 5G wireless networks will best be tested with portable analyzers and OTA measurement methods. (Courtesy of Rohde & Schwarz)



Most 5G carriers expect about a five-year buildup period for their networks with major investments in hardware, since the cost of RF/microwave components tends to increase with increasing frequency. Leading device manufacturers such as Intel, Qualcomm, and Texas Instruments are working to reduce the costs of RF/microwave components such as radio transceivers at higher mmWave frequencies. They're accomplishing this through the dense integration of components within ICs and multilayer circuit modules that can serve both 5G UE devices and base stations. In general, 5G UE devices and base stations will be highly integrated, which is notable at higher frequencies where array antennas are tightly integrated with radio electronics, making it difficult to characterize 5G radio circuits using traditional test methods.

#### TESTING THE FUTURE

In 5G SA base stations, the multiple-band radio equipment will operate on its own, while in NSA base stations, it will share real estate with earlier-generation wireless base stations. The radio portion of a 5G base station will be a separate unit than the controller electronics, a remote radio head (RRH), with the two units interconnected by

optical cables. Due to the propagation characteristics of mmWave signals (poor penetration of solid objects such as building walls), RRHs will be mounted where needed for maximum coverage, such as on building rooftops and within buildings (Fig. 3). However, such locations may make access with test equipment difficult.

Due to the many hundreds and thousands of base stations and microcells that will be needed and constructed during the next five years, different measurement approaches will be required to characterize and maintain the performance of 5G RRHs. This includes over-the-air (OTA) testing for locations where it's impractical to make a physical (coaxial cable) connection between the RRH and a signal analyzer (Fig. 4).

OTA testing performs measurements of a UE device or base station at some distance from the antennas in the device under test (DUT) using a calibrated measurement antenna connected to the signal analyzer. In the case of a smaller DUT such as a smartphone, OTA measurements are performed within a shielded room or enclosure. Once installed, 5G base stations can also be checked for performance levels and coverage within an area using OTA measurements.

Clearly, 5G wireless network coverage is in its infancy in many locations. Some locations, such as China, Japan, and South Korea, are further along in constructing the 5G network infrastructure needed to meet the bold claims of 5G service providers. However, the investments and the commitments to building 5G wireless networks are strong.

It's clear that the next five years will be active times for suppliers of UE device chipsets, for infrastructure radio equipment suppliers in both FR1 and FR2 frequency ranges, for suppliers of test hardware and software in support of OTA measurements, and even for suppliers of the potentially millions of kilometers of fiber-optic cables needed in the integration of 5G base-station subsystems. It's important to remember that 5G networks will be multilayered systems operating in basically three different frequency bands and wireless functionality and performance will grow as 5G infrastructure builds up.

Many functions remain well-served by 4G LTE systems. As 5G networks expand, they will add to the possibilities of 5G technology especially in vertical markets, such as autonomous vehicles, wireless and IoT-enabled robotic factories and warehouses, and wireless healthcare and remote medical care. **mtw**

# ACCOMPLISH YOUR MISSION WITH THE SMALLEST MOST COST EFFECTIVE CUSTOM RF/MICROWAVE FILTERS



Miniature SMT,  
Cavity Filters,  
available from  
5.0 to 25 GHz



Nano, SMT Filters,  
available from 40  
MHz to 6.0 GHz,  
in LC and Ceramic  
Topologies



Pico, SMT  
Filters, available  
from 5.0 GHz to  
27 GHz



Miniature  
Filters, rated for  
Mil-Std-202;  
compliant with  
RoHS and NON-  
RoHS options.

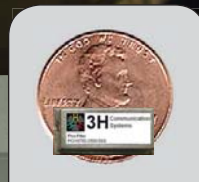

Miniature  
Diplexers,  
available from  
40 MHz to  
27 GHz

When an off-the-shelf filter could compromise your mission, call on 3H Communication Systems for the support you need. 3H specializes in high-performance custom RF/microwave filter solutions from DC to 50GHz.

- Custom-designed to meet the most critical performance and size requirements
- 3H has extensive experience with defense and prime contractors
- Cavity, Lumped Component and Ceramic topologies, connectorized and/or SMT formats; printed, suspended substrate, switch filter banks and multi-function assemblies
- ISO9001:2015 certified facilities with products backed by 5-year warranty

# Metamaterials

## Boost MRI Performance without Increased Magnetic Field

Using an array of helical coils formed on a metamaterial core, a research team greatly improved the performance of an MRI machine without having to ramp up magnetic-field intensity.

Improving the resolution, signal-to-noise ratio (SNR), and other performance attributes of magnetic-resonance-imaging (MRI) systems generally requires stronger magnetic fields in addition to other improvements. Present medical MRIs have magnetic-field strengths from as low as 1.5 tesla (T) up to 7 T, and some have even higher-strength fields. However, increasing field strength is a costly, bulky, complex step-up in the machine's design, construction, installation, power demands, operation, and maintenance.

Now, a team at the Boston University Photonics Center has devised a way to boost MRI performance without resorting to these stronger magnetic fields. They use a magnetic metamaterial made of helical resonators, which are 3-cm-tall structures created from 3D-printed plastic, and coils of thin copper wire (*Fig. 1*). These resonators are then grouped in an array that's flexible enough to cover the body part being imaged and interact with the magnetic field of the machine, resulting in an increase in effective SNR. Alternatively, it can also allow use of lower-strength MRI machines, providing comparable performance or faster scan times.



**1. Schematic of the magnetic metamaterial:** The metamaterial array composes unit cells featuring metallic helices, which are made of copper wiring with central polymeric scaffolding (scale bar is 3 cm). (Source: Boston University)

This isn't the first use of some sort of field-shaping adjunct to boost performance. Various resonator arrays have been explored as well as magneto-inductive waveguides. However, these have had detrimental issues related to magnetic-field inhomogeneity and the potential for generating strong electric fields, raising potential safety concerns.

The primary figure of merit is the magnetic-field enhancement ratio of the metamaterials, which is a function

of many variables including resonator diameter, spacing, and placement. The array of metallic helical unit cells yields collective resonant modes to interact with the magnetic field in MRI. The team performed many EM-field simulations across these variables, among them the ones shown in *Figure 2*.

Beyond simulation, they tested their approach by scanning chicken legs, tomatoes, and grapes using a 1.5 T machine (*Fig. 3*). Results showed the



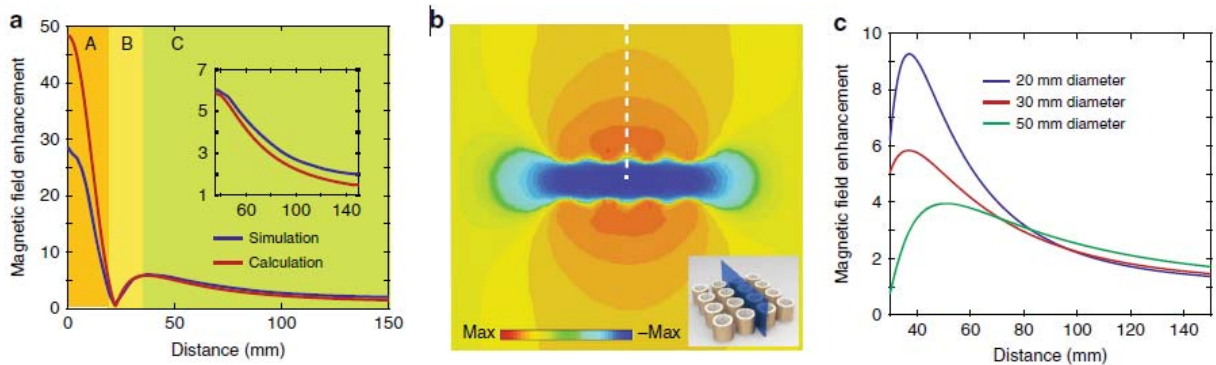

**2. Magnetic-field enhancement ratio of the metamaterials:** The magnetic field enhancement ratio as function of distance from the center of the metamaterial array (a, along the white dashed line in b) with simulation and calculation results in blue and red. Regions A, B, and C correspond to the regions within the metamaterial array, the region extending from the surface of the metamaterial to the peak enhancement ratio, and the “sample region” beyond the peak enhancement, respectively. The inset illustrates an extended plot of Region C (“sample region”). Also shown is the magnetic field strength along the axial direction distributed at the cross-section depicted as the blue rectangle in the inset (b), and the theoretical magnetic-field enhancement ratio of metamaterials with unit cells with different diameters (c). (Source: Boston University)

“If you are able to deliver something that can increase SNR by a significant margin, we can start to think about possibilities that didn’t exist before. Being able to simplify this advanced technology is very appealing.”

magnetic metamaterial yielded a 4.2X increase in the SNR.

Project leaders Xin Zhang, professor of mechanical engineering, electrical and computer engineering, biomedical engineering, and materials science and engineering at the College of Engineering and a BU Photonics Center faculty member, along with Stephan Anderson, School of Medicine professor of radiology, vice chairman of research in Boston Medical Center’s radiology department, and a Photonics Center faculty member) hope to partner with industry collaborators so that their magnetic metamaterial can be adapted for real-world clinical applications as well as applications in non-clinical settings.

“If you are able to deliver something that can increase SNR by a significant margin, we can start to think about

possibilities that didn’t exist before,” says Anderson. This could include having MRI near battlefields or in other remote locations. “Being able to simplify this advanced technology is very appealing.”

All aspects of the project are described in elaborate detail in their paper “Boosting magnetic resonance imaging signal-to-noise ratio using magnetic metamaterials” along with its Supplementary Information, which includes extensive EM-field and other analyses, published in Nature’s *Communications Physics*. The work was supported by the National Institutes of Health, the Boston University College of Engineering Dean’s Catalyst Award, the Boston University Wallace H. Coulter Translational Research Partnership Award, and the Boston University Ignition Award. [MW](#)

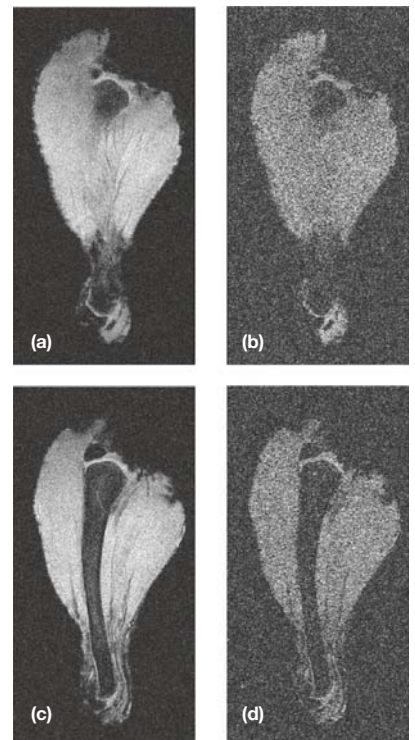

**3. MRI scan of a chicken leg.** Images acquired 2.25 cm (a, b) and 2.50 cm (c, d), from the top surface of the metamaterial array. Images (a, c) are acquired in the presence of the metamaterial array, while images (b, d) are acquired in the absence of the metamaterial array. All other conditions remained fixed between scans. (Source: Boston University)

# WAVEGUIDE

## Makes a Comeback in 5G—for Antennas

Waveguide is taking on a new role in the next generation of wireless systems in small form factors considered inconceivable before.

**F**or most design engineers, study of waveguide technology ended when they got their last degree. The only time waveguide comes up is to use it as a last resort in applications such as millimeter-wave (mmWave) measurements, where coaxial cable is too lossy, expensive, and fragile. That's not to say waveguide isn't used anymore, but it's not considered "modern" technology and of little use in applications such as wireless. However, that perception is beginning to change, and the needs for waveguide's benefits at mmWave frequencies for 5G are driving substantial amounts of research around the world.

The market for waveguide, and the components made from it, is remarkably stable and continues to grow. Depending on analysts, this growth is expected to be from 5% to 20% through the early 2020s. In its "Millimeter Wave Technology Market 2019-2023," 360 Research Reports notes: "There has been a remarkable increase in antenna developments from waveguide slot antennas," driven by mmWave radars and interest in "design and implementation of efficient and miniaturized antennas for mobile communications and radio communication equipment."

That's remarkable in an era when systems of all kinds are shrinking and powered by low-power solid-state devices, and except for those who actively seek it, information about waveguide antennas is rarely covered in the media. However, many research papers concerning new waveguide antenna designs appear every year. Many of them are related not to traditional applications such as defense systems, but rather to their potential use in deploying commercial wireless networks.

The reason for this interest lies in the basic characteristics of waveguide, which when compared with its counterpart, coaxial transmission line, has unique benefits. For example, while coaxial cable is far easier to use, its performance declines with frequency. And at millimeter wavelengths above about 30 Hz, insertion loss becomes increasingly problematic and its size shrinks to the size of a pencil lead, making it extremely fragile and expensive.

Only air has lower insertion loss than waveguide, and it's virtually impervious to external interference, handles much higher levels of RF power, and operates over wide bandwidths. The RF power-handling ability of coaxial cables is quite high at high frequencies, especially when using air rather than PTFE

as the dielectric, but it falls off rapidly with frequency to a watt or less at high millimeter wavelengths.

That said, at lower frequencies, metal waveguide is huge when compared to coaxial cable, and for applications at 1 GHz and below it's truly enormous, fulfilling its derogative moniker as "microwave plumbing." Even the flexible versions of waveguide are comparatively difficult to install and require special couplings.

Because of its size, most waveguide applications today are confined to test and measurement, radar and electronic warfare systems, point-to-point links, satellite terminals, broadcast transmitters, medical systems, and linear accelerators and other scientific systems. But at frequencies above about 30 GHz, waveguide comes into its own, and as frequency increases, it becomes the only reasonable solution for transferring energy over a physical medium with low loss. In the future, it holds great potential for mmWave antennas, too.

### WAVEGUIDE FOR 5G?

One of the core tenets of the fifth generation of wireless communications is the use of mmWave frequencies. They're needed to accommodate the extremely wide channel bandwidths

required by high-definition video streaming and other data-intensive applications, as well as the low latency required by applications such as autonomous vehicles, tele-surgery, gaming, and many industrial applications. To realize operation in this spectral region, advanced antenna architectures will be crucial. Although waveguide-based antennas are rarely mentioned in the same sentence as 5G, they will likely play an important role at millimeter wavelengths.

To facilitate the development of mmWave technology around 60 GHz for Wi-Fi and potentially the next generation of cellular technology, Pasternack in 2014 introduced the PEM003-KIT transmit/receive development system for creating transmission paths at varying distances and vary key parameters to verify and optimize the performance of designs. At the time it was introduced, 60 GHz seemed a bit far out in terms of deployment. However, in the last two years, the kit has gained popularity as designers and experimenters realize that 60 GHz will likely be in their sights sooner rather than later.

The PEM033-KIT consists of transmitter and receiver printed circuit boards and WR15/WG2 waveguide antenna modules that create transmission and reception paths, along with Windows software that acts as a control panel for system monitoring, configuration, and experimentation (*Fig. 1*). Two antenna modules are available: For distances between 30 to 50 m, a WR-15 antenna delivers gain of 15 dBi, and for distances between 200 to 300 m, a WR15 horn antenna delivers 34 dBi of gain.

## **TWENTY-FIRST CENTURY WAVEGUIDE**

A variety of waveguide antenna techniques can be used to achieve excellent results by combining the



**1. Pasternack's 60-GHz development kit helps designers get accustomed to the millimeter-wave frontier.**

inherent characteristics of waveguide and fabrication using cost-effective methods. Depending on their architecture, these antennas can provide directional or omnidirectional coverage and electronically steered beams. Active beamsteering, regardless of the technology used to implement it, is essential for combating the challenging propagation characteristics at millimeter wavelengths.

The majority of the traditional waveguide antennas are standard rectangular, or conical, gain horns, with directional radiation patterns. For wireless communication applications, like 5G, other radiation patterns may be required for desired coverage, such as omnidirectional and sector patterns. In addition, dual polarization and circular polarization may be needed for

optimized communications. Pasternack has introduced these categories of waveguide antennas, as well as high-gain lens gain horns.

One such antenna is the slotted waveguide antenna array (SWAA), which has been used since World War II in various radar applications, especially rotating commercial S-band (2 to 4 GHz) marine radars where cost and simplicity are key metrics. SWAAs consist of lengths of circular or rectangular waveguide with slots milled into their conducting walls. These slots introduce discontinuities in the conductor and interrupt the current flow in the waveguide wall. As current flows around the edges of the slots, they act as dipole antennas. The waveguide itself acts as the transmission line feeding the antenna elements.



◀ 2. The omnidirectional ring-based SWAA antenna from researchers in Brazil is designed to deliver coverage indoors or outdoors with substantial gain.

▶ 3. This 2,000-element SWAA from Mitsubishi Electric and Hiroshima Institute of Technology is designed for use in weather and surveillance radars.



Researchers at the National Institute of Telecommunications and the Federal University of Itajubá in Brazil developed SWAAs that have the potential for use in 5G networks.<sup>1</sup> One of these, designed for operation between 24 and 33 GHz, combines high gain and omnidirectional coverage using circular waveguide filled with PTFE that acts as a mechanical support for the antenna structure (Fig. 2).

It stated applications include shopping malls, theaters, convention centers, and stadiums.

The researchers also developed a dual-band SWAA that uses sets of slots on each of the rectangular waveguide's broader face, one for 28 GHz and the other for 38 GHz, allowing both bands to be used simultaneously. The antenna measures  $1.7 \times 24 \times 87$  mm and provides bandwidths of 24.72 to 32.2 GHz and

higher frequencies. Because it's made from injection-molded resin rather than metal, it's 40% lighter and 90% less expensive than a patch array of the same size. Furthermore, it offers 60% sidelobe suppression, a 90% reduction in cross-polarization, and 10% greater efficiency.

Another promising technology is substrate integrated waveguide (SIW), which uses printed structures that emulate metal waveguide but are lightweight,

**One of the most impressive large-scale SWAA antennas was announced early last year by Mitsubishi Electric and Hiroshima Institute of Technology (Fig. 3). The 2,000-element dual-polarized array is designed for weather, airport radar, remote-sensing radar, and satellite communications, but the concept could be applied to smaller arrays at higher frequencies.**

The circular slots in the waveguide are equally spaced. They act as metal rings within a dielectric rod in which the waves function much like a leaky-wave antenna. RF energy is radiated outward through the slots, producing omnidirectional coverage. The conical horn of the lower part of the antenna measures  $15 \times 9.9$  mm and is fed by a K connector. The antenna produces gain of about 12 dBi at 28 GHz and has a 2.15-GHz bandwidth.

35.5 to 39.15 GHz with gain of 12.6 and 15.6 dBi, respectively.

One of the most impressive large-scale SWAA antennas was announced early last year by Mitsubishi Electric and Hiroshima Institute of Technology (Fig. 3). The 2,000-element dual-polarized array is designed for weather, airport radar, remote-sensing radar, and satellite communications, but the concept could be applied to smaller arrays at

have a low profile and low insertion loss, and are easy to manufacture. SIW technology allows for integration of passive and active components and antennas in a single substrate. It's a promising technology not only for antennas, but for phase shifters, oscillators, resonators, filters, and other passive components, forming substrate integrated circuits (SiCs). They can be directly connected to planar circuits, namely microstrip

*INSTRUMENT GRADE*  
**WAVEGUIDE FILTERS**

*to 86 GHz*

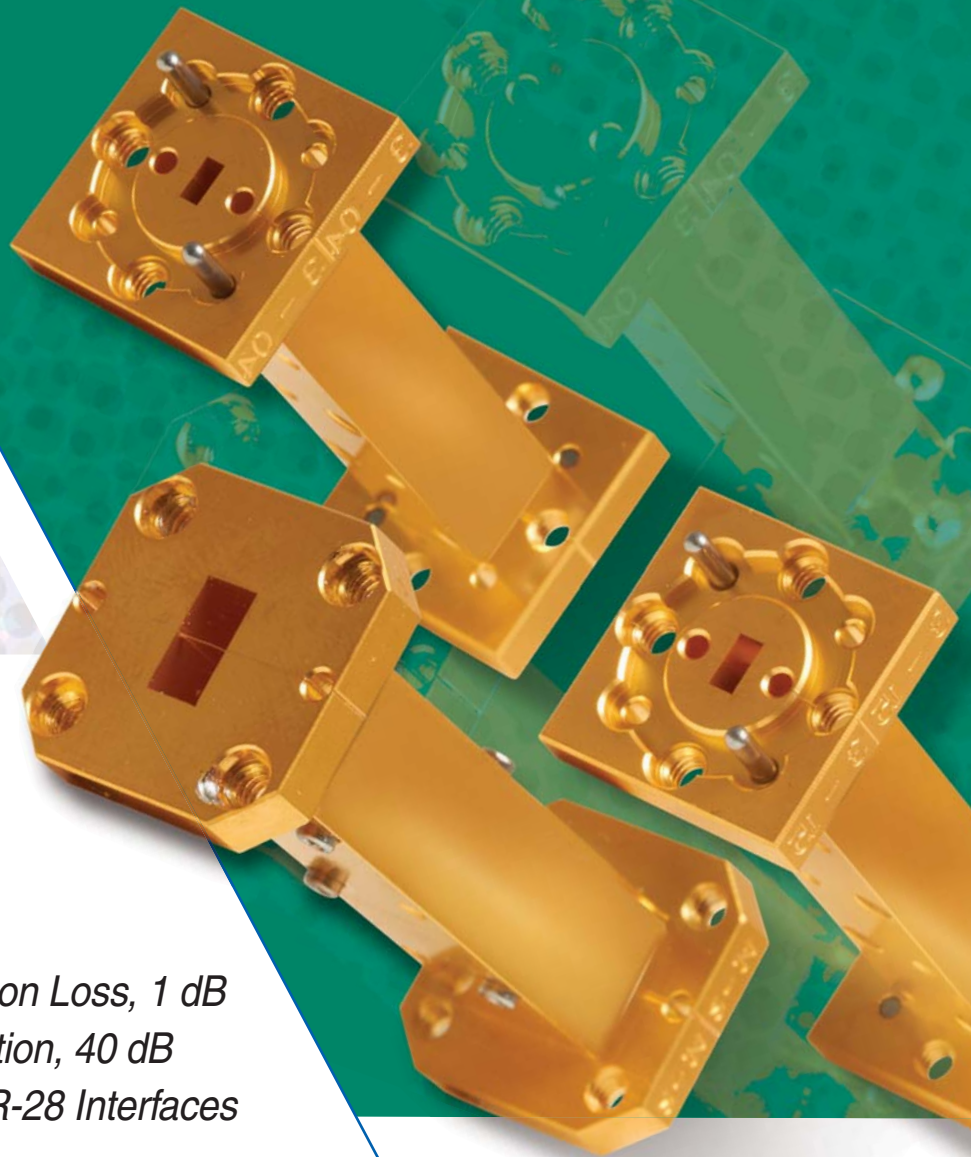

- ▶ *Low Passband Insertion Loss, 1 dB*
- ▶ *High Stopband Rejection, 40 dB*
- ▶ *WR-12, WR-15, & WR-28 Interfaces*



If there's any market that will foster the continued development of waveguide technology in the coming years, it will be the wireless industry, because no other needs it more.

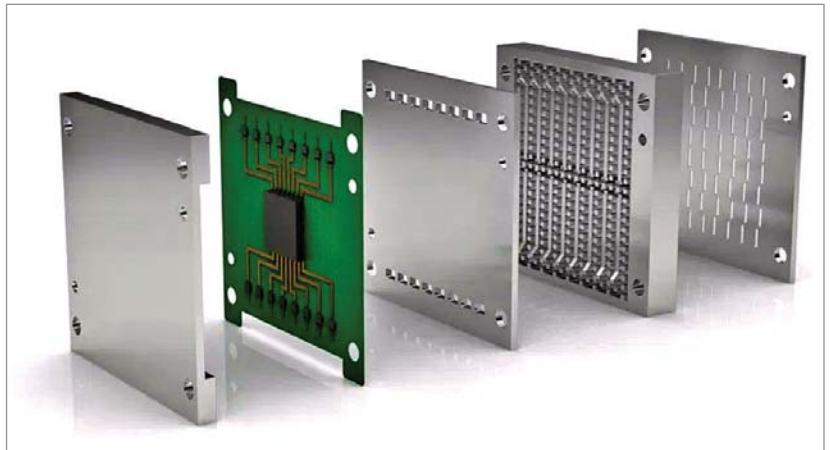

4. The Gapwaves “gap waveguide” technology can be used to build a compact 28-GHz phased array while integrating active components to produce a complete subsystem.

line and coplanar waveguide, making it suitable for mass production.

SIW falls between microchip line and dielectric-filled waveguide in which the metal on both sides of a dielectric substrate (microwave laminate) acts as the waveguide's top and bottom walls. A dense array of metallized posts connects to the upper and lower plates of the substrate. There are multiple variations on SIW that enhance its capabilities while reducing size and complexity.

For example, half-mode SIW reduces the amount of vertical metallization to half that of a full SIW implementation, increases operating bandwidth, and can function effectively up to about 100 GHz. The latest versions of this technique eliminate the via holes and the dielectric substrate, replacing it with an air-filled structure while maintaining the advantage of integration on a planar substrate.<sup>2</sup> As a result, the technique may allow SIW to be at even higher frequencies.

Other researchers have developed a double-sided, 4x4 element SIW slot antenna using a stripline feed.<sup>3</sup> The antenna and its feed are fabricated on a single substrate with two dielectric layers and three copper layers, resulting in its small size, low profile, low cost, and two radiation directions. The antenna can be used at 25 and 28 GHz with 8-dBi gain, 63-deg. half-power beamwidth, and a 2-GHz bandwidth.

Still another technique is half-mode composite waveguide (MCW). It con-

sists of inner and outer waveguide structures in which the outer structure acts as a rectangular coaxial line for lower-frequency operation while the inner structure acts as a rectangular waveguide for higher-frequency operation. A half-mode version (HMCW) has inner and outer waveguide that operates in half-mode. When compared to its full-size counterpart, it occupies half the space with comparable insertion loss.

Finally, Gapwaves, a Swedish company founded by the late Per-Simon Kildal, a researcher and professor at Chalmers University of Technology, developed a commercial product based on techniques quite different from others called a gap waveguide. A structured metal surface and flat metal surface are placed close together, with the structured surface having pins that form a metamaterial surface referred to as an artificial magnetic conductor (Fig. 4).

The pins prevent RF energy from propagating in undesired directions. Thus, the pins effectively replace the walls in a conventional rectangular waveguide—without the need for a sealed metallic enclosure. The waves propagate in the air gap between the ridges and the top metal surface with low loss, and no metallic contact is required between the two parts, so assembly is comparatively simple.

A 28-GHz phased-array using this technology can deliver effective radiated power of 65 dBm in a small form factor. It also allows for integration and direct antenna contact with other active or passive components by replacing the flat metal surface with a circuit board. The company is integrating GaN front-end modules, filters, a beamforming chip set, and other components to produce a complete subsystem.

#### SUMMARY

These represent just a few of the many ways that researchers are exploiting the properties of waveguide to create antennas that a decade ago would have been of little interest for commercial applications. However, if there's any market that will foster the continued development of waveguide technology in the coming years, it will be the wireless industry, because no other needs it more. [mtw](#)

#### REFERENCES

1. Arismar Cerqueira Sodre, et al, National Institute of Telecommunications (INATEL), “Waveguide-Based Antenna Arrays for 5G Networks”, *International Journal of Antennas and Propagation*, Volume 2018.
2. Lindo Ouseph, Anju Mathews, and Aanandan Chandroth, MPRL, Department of Electronics, CUSAT, India, *Substrate Integrated Waveguide without Metallized Wall Posts*, MPRL, Department of Electronics, CUSAT, India.
3. Roberto Di Renna, L.J. Matos, Tadeu N. Ferreira, Jorge Souza, “A new double-sided substrate-integrated waveguide slot array antenna for 5G applications”, 2019 IEEE International Symposium on Antennas and Propagation and USNC-URSI Radio Science Meeting, APSURSI 2019 – Proceedings.

# Delivering 5G Devices to Market Will Bank on OTA Testing

As 5G begins to leverage high-frequency mmWave bands, engineers that used to work at RF frequencies will once again need to sharpen their skill sets and adopt new design and testing techniques.

**T**he biggest challenge in testing 5G devices, as opposed to 4G/LTE, is the reliance on active antenna arrays and high RF frequencies. These frequencies are far higher than what we have ever used before in a commercial communication system. Frequency range 1 (FR1), which will transmit most of the traditional cellular communications traffic, has been designated for 450 to 7125 MHz. Frequency range 2 (FR2) will employ millimeter-wave (mmWave) frequencies (24,250 to 52,600 MHz) to deliver short-range, high-data-rate transmission.

Higher frequency bands combined with extended bandwidths in the mmWave range will place much higher demands on the components for 5G communications devices and systems, including the filters, mixers, amplifiers, analog beamforming chipsets, and antennas.

For FR1, which is sub-6-GHz, testing can still be performed using cables. But at FR2, it will be necessary to consider the entire assembly as one entity, including the antenna, phase shifters, amplifiers, attenuators, and more. Testing needs to be performed at a system level, so that connectors and cables don't interfere with the system characterization.

## NEW TECHNOLOGIES, MORE COMPLEXITY

FR2 products are becoming very complex. They're comprised of phased-array antennas; each is built of many antenna elements, every one with its own phase shifter and amplifier, working collectively to steer a signal in a desired direction.

In this case, if testing is performed using a connector that bypasses the antenna array, it's impossible to gauge how the overall system performs: If the system lacks proper beamsteering or gain, or if the components behind it are too noisy and impact the modulation of the signal, it will not be discovered during the testing phase. Therefore, it's critical to characterize the entire system—the radio and the phased-array antenna together.

In multiple-input, multiple-output (MIMO) technology, multiple antennas are used at both the transmitting and receiving points, creating a circuit that minimizes errors and optimizes speed. Traditionally, testing MIMO signals has focused on testing the transmitter/receiver system and the quality of the channel. Facilitating commercially feasible testing in 5G devices could be a challenge.

However, when designing a massive-MIMO active antenna system, devel-



Shown is Rohde & Schwarz's ATS800R rack-mount CATR system that performs OTA testing.

opment engineers face new challenges that include phase-shifter tolerances, thermal effects of the power amplifiers (PAs), and frequency drifts between modules that affect the desired beam patterns.

In an active antenna system, the transceiver front-ends are integrated

*MILLIMETER WAVE*  
**MMMIC**  
*PRODUCTS*

**MULTI-OCTAVE BANDWIDTHS**  
**UP TO 43.5 GHz**

*Amplifiers | Attenuators | Couplers | Equalizers | Mixers*  
*Multipliers | Reflectionless Filters | Splitter/Combiners*



Now over 60 MMIC models *In Stock*  
covering applications above 26 GHz



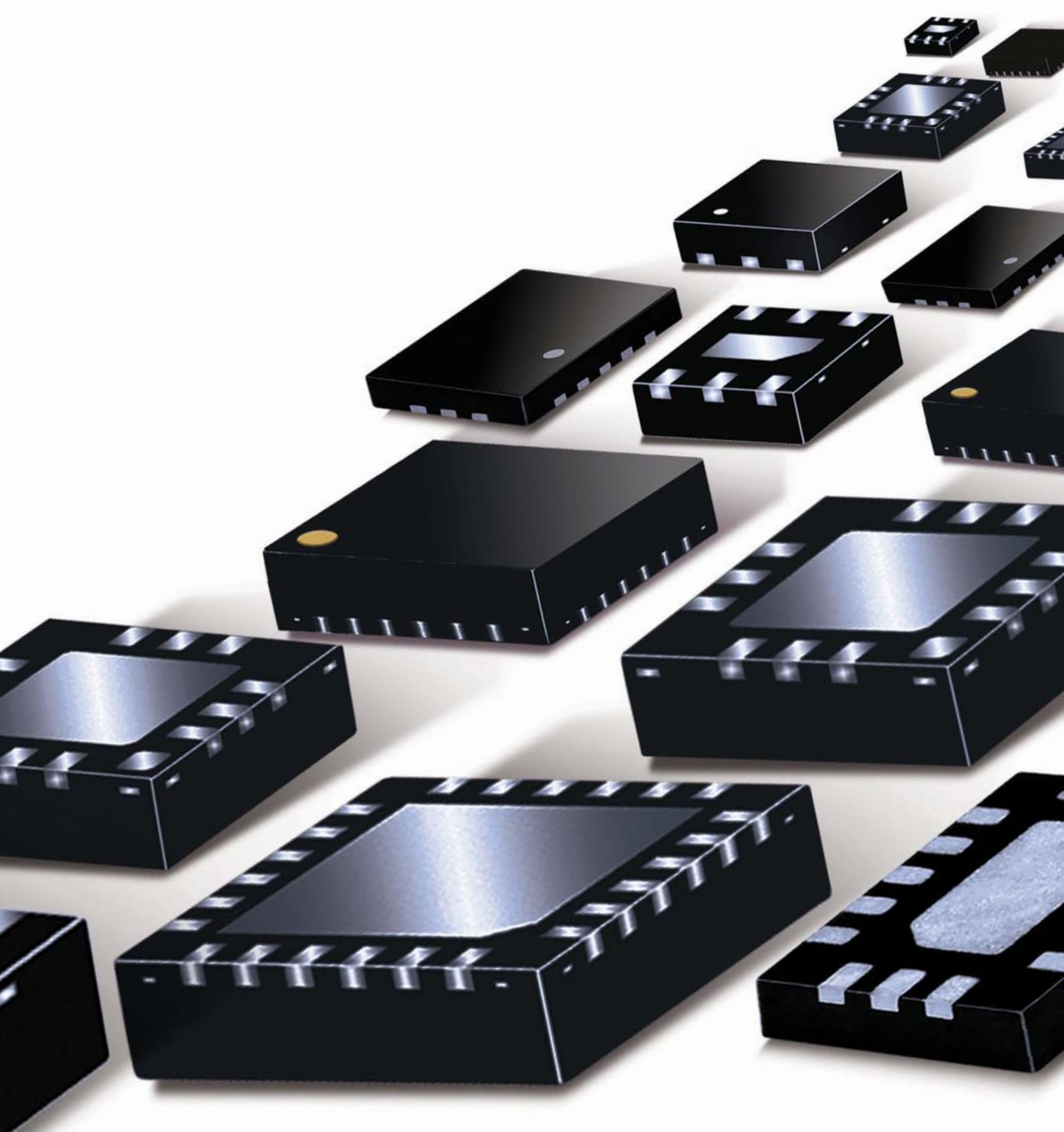

*Available in Plastic SMT & Unpackaged Die*



(718) 934-4500 sales@minicircuits.com www.minicircuits.com



598 Rev A\_P

together with the antenna array, which means that traditional RF output ports are no longer accessible. In addition, a fiber interface replaces the traditional RF input ports for digital I/Q data. Consequently, over-the-air (OTA) testing becomes the default use case for massive-MIMO systems and for modeling the spatial properties of the propagation channel. Due to the different sizes of massive-MIMO systems, testing in far-field conditions requires a variety of shielding environments.

It's still a bit early to consider what a MIMO test solution for 5G will look like. Nonetheless, we anticipate the need to consider multiple angles of arrival of signal, application of the proper fading channels, etc. Currently, it's difficult to see what this looks like for FR2.

The 3rd Generation Partnership Project (3GPP), which unites seven telecommunications standard development organizations (ARIB, ATIS, CCSA, ETSI, TSDSI, TTA, and TTC), is actively developing the reports and specifications that define 5G technologies. The project covers cellular telecommunications technologies, including radio access, core network, and service capabilities, which provide a complete system description for mobile telecommunications.

The 3GPP technologies from these groups are constantly evolving through generations of commercial cellular/mobile systems. With its LTE, LTE-Advanced, LTE Advanced Pro, and 5G work, 3GPP has become the focal point for the vast majority of mobile systems beyond 3G. A number of Rohde & Schwarz representatives regularly attend 3GPP's meetings globally, including those of the standards committees, and the company has contributed input and feedback on testing devices and systems to meet the specifications the organization lays out. When the standards are finalized, they will drive the future certification process.

The major focus for all 3GPP Releases is to make the system backward- and forward-compatible where possible, to ensure that the operation of user equipment is uninterrupted. For 5G, many operators are starting with dual connectivity between LTE and 5G NR equipment—using a non-standalone specification detailed in Release 15 that was completed earlier this year. Care has been taken to build forward compatibility into non-standalone NR equipment, to ensure that it will be fit for use on standalone 5G NR systems.

### THE EVOLUTION OF OTA TESTING

In terms of testing, the standards are changing from connectorized measurements to an indirect far-field measurement using a compact antenna test range (CATR), as it provides the most flexibility and a practical solution moving forward. For example, if you were to measure an FR2 phased array in a true far-field chamber, you would be looking at a range length of several meters, which is impractical.

Today's systems can execute the antenna characterization or antenna check using test solutions such as a compact antenna range that emulates far-field conditions within a smaller area/footprint. Moving forward, CATR will be the test system of choice to test phased arrays at high frequencies for user equipment.

One such compact solution is the AT800R from Rohde & Schwarz, a vertical rack-mount CATR system (*see figure on page 29*). The device can be placed on a table to characterize the phased arrays and facilitate quick measurements—such as EVM, ACLR, EIRP, or beamsteering measurement—within a 20-cm quiet zone. Although not automated, an adjacent device under test (DUT) can be quickly, fully characterized, which is beneficial for R&D functions as well as for a production environment.

OTA testing will be critical for ensuring that 5G devices will perform

in the real world. The 5G device is placed in a test chamber and tested in simulated conditions to see how it responds. In addition to verifying the performance, such testing will certify that products meet specified standards, from both a modulated perspective and an antenna perspective. For example, a vector signal generator can provide a modulated 5G signal, while a spectrum analyzer can help analyze those signals with special measurement profiles, to verify unimpeded transmission between the signal source and the device.

White box testing was sufficient for sub-6-GHz devices for 2G, 3G, and 4G, as the far-field conditions were not as vast as we'll see with the FR2 band. The latter frequency range is designed for applications that would not allow for a direct line of sight from the DUT to measurement probe. White box testing enables the measurement antenna to look directly at the center of rotation, and the tester knows the antenna's precise location. Positioning is very important in white box testing, since it uses the far-field condition directly.

While a direct far-field system may allow for testing of larger devices, it's not practical at higher frequencies. FR2 will require black box testing, either because the antenna position is unknown or there's a need to measure an entire system or product. This testing method uses indirect far-field (CATR), which doesn't require exact positioning because an indirect wave measures the device. The measurement system is pointed at the reflector and filters out the spherical wave component to reflect the planar wave back toward the DUT.

Modern highly integrated chipsets, front-ends, and antenna systems require new techniques for OTA measurements in a multitude of development steps. Integrating the antenna or antenna array into the chipset poses challenges in beamforming verification and chipset or

# USB/ETHERNET SWITCH MATRICES



**NOW!**  
**DC to 40GHz**

- ▶ Extra-Long Switch Life Up to 100 Million Cycles\*
- ▶ User-Friendly GUI and DLLs Included
- ▶ Compatible with Most Third Party Lab Software†
- ▶ Switch Cycle Counting Feature with Automatic Calibration Alerts
- ▶ Small Enough to Fit in Your Laptop Case

\* With factory cleaning service. Varies by model. See individual datasheets for details. Switches protected by US patents 5,272,458; 6,650,210; 6,414,577; 7,843,289; and additional patents pending.  
† See data sheet for a full list of compatible software.



(718) 934-4500 sales@minicircuits.com [www.minicircuits.com](http://www.minicircuits.com)



603 Rev A\_P

amplifier testing. With the use of state-of-the-art test-and-measurement equipment in lab environments, shielded boxes, or large anechoic chambers, the challenge of OTA testing largely comes down to understanding key challenges in antenna measurement and chamber setup.

It's important to keep in mind that conformance testing will change considerably for FR2 frequencies, leaning toward OTA testing over conducted tests. Engineers will need to know how to calibrate the systems and understand what they are measuring. This will require a bit of homework on their part, perhaps working closely with antenna manufacturers.

### 5G PRODUCTION TESTING

In addition, 5G production testing, which is still evolving, should be recognized as much more of a challenge for R&D due to the high volumes involved.

Production speed ultimately will be impacted by the types of measurements required as well as the length of time it takes to measure and record the measurement.

However, OTA systems for FR2 can be used without a front door in an R&D environment, which saves time placing and removing devices in the chamber and is further conducive to a production environment when a reflector is mounted above the manufacturing line. Such a setup enables a CATR system to easily measure bore sight, off-peak, null definition, beamsteering accuracy, and more.

Production testing for FR2, though, currently remains in the R&D stage for the most part, as manufacturers focus on developing the right design. When 5G becomes mainstream, test-and-measurement designs will need to quickly evolve and align with standards and specifications.

### CLOSING THE KNOWLEDGE GAP: THE NEW DIGITAL DIVIDE

Millimeter-wave engineering is considerably different than RF engineering. At mmWave, components act differently. At low frequencies, engineers don't need to account for the phase properties of a wavelength since wavelengths are large in comparison to the component size. But at mmWave, in which frequencies are high and wavelengths are small, the wave properties of the signals must be considered.

As 5G begins to leverage high-frequency mmWave bands, engineers that used to work at RF frequencies will once again need to sharpen their skill sets and adopt new design and testing techniques. To learn more about the technologies shaping our future wireless world, please visit the 5G Learning Center at [www.mobilewirelesstesting.com](http://www.mobilewirelesstesting.com) or the Rohde & Schwarz website at [www.rohde-schwarz.com/5G](http://www.rohde-schwarz.com/5G). 

## 94 GHz Sockets

High Speed Microwave Applications

- Contact resistance <30 mOhms
- Bandwidth >94GHz @-1dB
- Current 5.4A @ 20C rise
- Force 25-50 grams per contact
- Operating temperature -55 to +160C
- Insertion/Extraction cycles>1000
- Contact length (compressed): 0.08mm
- Compliance: 0.15mm

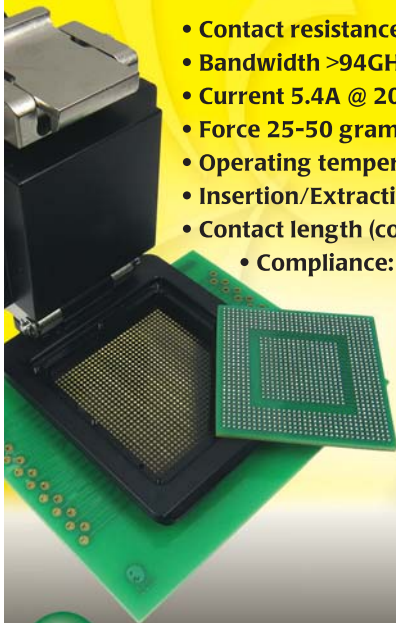

 **Ironwood**  
ELECTRONICS 1-800-404-0204  
[www.ironwoodelectronics.com](http://www.ironwoodelectronics.com)

## New Avionics Transistor and Evaluation Amplifier

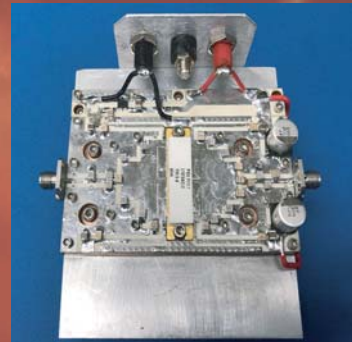

Pictured is the LY2542LB transistor mounted in the TB271 evaluation amplifier; 800W (128us, 10%), 960-1215MHz, 15dB. Available now.



polyfet rf devices

[www.polyfet.com](http://www.polyfet.com)

TEL (805)484-4210

Your  
Power  
MOSFET  
People

# 11 Myths About OpenVPX and the SOSA Initiative

**P**aradigm shifts in technology initiatives don't come without their skeptics, as is the case with the DoD's Hardware/Software Convergence Initiative. Aimed at developing a common, modular hardware architecture across C4ISR and EW systems, this program combines separate efforts initially undertaken by the U.S. Army under CERDEC (CMOSS), the U.S. Navy under NAVAIR (HOST), and the Air Force under AFLCMC into one, cohesive COTS-based, open standards initiative.

Now managed entirely under Sensor Open Systems Architecture (SOSA), this collection of open architecture standards provides reconfigurable, upgradable, and cost-effective C4ISR capabilities in deployed platforms across sensor applications throughout all major military branches. Using OpenVPX as its basis, it's setting the standard for interoperable systems across several defense branches to improve subsystem SWaP, enable rapid technology insertion, and promote reuse.

It's important to understand how both OpenVPX's history in military environments as well as its pedigree as a ratified industry standard can help facilitate this widespread, and seemingly complex, undertaking to break from the old method of costly proprietary computing systems.

Below, some common misconceptions about OpenVPX are dispelled, and we examine how it can provide the right environment for the SOSA initiative

## 1. THE CARD ISN'T GOING TO BE COMPATIBLE.

This depends on whether the target backplane is a VITA 65.0 standard development backplane or a customer-driven deployed backplane. The VITA 65.0 standard development backplanes have very simple topologies that are compatible with lots of cards. Actual VPX system backplanes have much more complex topologies with many I/O signals.

Consequently, these backplanes are usually designed for specific cards and map to the unique I/O mapping of one VPX module. With the development of fully defined SOSA VPX slot profiles, even complex backplanes will be wired for standard slot profiles, and the result will be more modules compatible with any given backplane implementation.

## 2. I WON'T BE ABLE TO GET ENOUGH POWER.

Enough power is no longer the problem—it's properly cooling the amount of available power. In the past, VME64x and

CompactPCI cards could each typically draw no more than 150 W from a backplane slot. As large FPGA silicon became available from companies such as Xilinx and Altera, the power needs of an individual card exceeded the amount of power that a card could draw because the pin assignments and contact design did not allow for more power.

3U VPX cards can draw over 270 W and 6U cards could draw over 380 W. It's unlikely that VPX systems will ever be limited due to power availability. And, new cooling standards are being released to allow more of this VPX power to be used in future systems.

## 3. I'LL NEED A CUSTOM BACKPLANE.

One of the main criticisms of the VPX architecture, and a fair one at that, is that it doesn't consider all of the other VPX features that have made the architecture so desirable. The mandate for custom backplanes is, therefore, being tolerated by designers.

A new solution designed to meet the need for fully customized VPX backplanes is on the horizon. Pioneered by hard-working technical groups under SOSA, emerging standard profile definitions will eliminate much of the need for VPX backplane slots to be wired for specific, unique VPX modules when using SOSA conforming plug-in cards.

## 4. I CAN'T RUN 10 Gb/s OUT OF THE BACKPLANE.

For some time, PCIe Gen2 and 10GBase-KX4 were thought to be the fastest protocols that could be reliably passed to I/O devices through cables, which plugged into VPX backplane RTM connectors. Recently, a new approach that utilizes new backplane materials, together with improved via design, has pushed this limit to PCIe Gen3 and 40GBase-KR4. It's highly likely that a new, backward-compatible VPX connector may even allow these higher speeds to be exceeded in the near future.

## 5. VITA 65 MAY NOT MEET ALL MY DESIGN NEEDS.

This was most likely said by those who haven't reviewed the current list of available features added to VPX. In fact, it's hard to imagine an application that could not be implemented within the standard. VPX is rugged and supports two card sizes. Some of the new features include miniature coaxial backplane feed-thru, backplane optical ribbons, radial clocks, 25-Gb/s channels, rugged vibration-resistant connectors, hybrid topologies, XMC sockets, as well as VITA 57.4 FPGA mezzanines

that support 28-Gb/s links between the base board and the mezzanine. The coaxial modules now available are causing an explosion of new applications.

### **6. ALL OF THE VPX CONNECTORS ARE EXPENSIVE BECAUSE THEY ARE SOLE-SOURCED.**

OpenVPX was built specifically with the goal of eliminating single-source pitfalls. To date, there are three suppliers of intermatable backplane connectors, one of which already offers three different versions of the VITA 46 connector. All versions are forward and backward-compatible.

The connectors cost more because of the performance they provide. These high-density, high-speed connectors allow space for XMC/PMC mezzanine sockets and fit within the 3U and 6U 160 Eurocard packaging formats. In addition, there are space-qualified, high-vibration-resistant, footprint-compatible VPX backplane/daughtercard connectors. Paying for the benefits of performance enhancement is true for whatever architecture you choose.

### **7. THE MULTI-CONNECTOR IS LIMITED TO 12 Gb/s.**

Although the current connector supports signaling up to 12 Gb/s, which is just beyond PCIe Gen3 and 10Base-KR Ethernet, a new backward-compatible version of the same MultiGig connector is being standardized and will support Ethernet lanes up to 25 Gb/s and Fat Pipes (FP) supporting 100GBase-KR4. This connector is both backward- and forward-compatible, so that old cards can be used in the new backplanes and new cards will be usable in the old backplanes. However, the speed will always have to be negotiated down to the least capable element in the path.

### **8. I CAN'T INSPECT VITA 66.1/66.4 OPTICAL MODULES IN THE FIELD.**

There's now an inspection card for 6U VPX conduction-cooled chassis that will automatically both inspect—and clean—VITA 66.1 optical modules installed in either the J3 or J6 position in a 6U VPX backplane.

Independent of the VPX system, this tool is tethered to a laptop running software that will execute multiple inspect/clean/inspect cycles until all of the fibers meet inspection requirements. Then, a new card can be inserted into the fully inspected VPX slot in the field. The hope is that this equipment will be extended to 3U VPX slots that are either in accordance with AV 48.1 or AV 48.2.

### **9. ISN'T AIR FLOW-THROUGH THE SAME AS CONVECTION COOLING?**

Not at all. Three different cooling methods are actually included in OpenVPX that all depend on forced air. While technically not “new,” since these methods have been used with VME for years for demanding applications, they're now

standardized. Check out VITA 48.5, 48.7, and 48.8. Each offers advantages over conventional forced air, because each method allows air to be directed specifically where it's needed.

### **10. I HEARD THAT THE VITA 46.11 IPMI-BASED SYSTEM MANAGER ISN'T REALLY SECURE ENOUGH FOR CYBERSECURITY.**

Your concerns have been heard, and the HOST and SOSA working groups are really beefing up the System Management approach and adding new capabilities, such as large file transfer support and IPMI 2.0 security. These two working groups are supported by a large team at the University of Georgia Research Institute, the U.S. Army, U.S. Air Force and NAVAIR, as well as individual companies and SBIR (Small Business Innovation Research) award winners. It's a level of cooperation never seen before.

### **11. CAN AN INTERMEDIATE FREQUENCY BE SHARED BETWEEN RADIO CARDS IN A VPX BACKPLANE? I'VE HEARD THAT THERE ISN'T SUFFICIENT ISOLATION.**

It's true that the MultiGig signal pins may not provide sufficient isolation between pairs to distribute an intermediate frequency between radio cards. However, VPX slots now support a variety of coaxial interfaces that can distribute an intermediate frequency or very precise clocks such as Precision Time Protocol (PTP) and Network Time Protocol (NTP).

VITA 67.3 only defines the opening in the backplane, the mounting holes, and alignment pins, and supports several sizes of modules as well as a growing number of unique contact configurations, including mixed coax and optical interfaces. These 67.3 modules are easily removed and replaced on the backplane, so reconfiguration is possible.

VITA is working to standardize additional contacts, but users are already employing coaxial contacts such as SMPM (multiple suppliers), nanoRF (TE currently), and SMPS (SVmicro). SMPM (many vendors) is lower density, but it supports the greatest variety of backside cable options including flexible, semi-rigid, and right-angle terminations. Some SMPM configurations are already standardized within VITA documents.

We're only addressing the backplane side because 67.3 was developed to support direct launch from the daughtercard mezzanines, though cable can also be used. Furthermore, VITA 67.3 modules can support new higher-density nanoRF and SMPS contacts. Half-size 67.3 modules with as many as 12 coaxial contacts are already in the marketplace and being used. The denser connectors only support flexible cables presently. These can be used to distribute the precision clocks already mentioned. You can also see a mix of SMPM and either nanoRF or SMPS contacts as well as optical MT ferrules combined in a single 67.3 module. [mmw](#)

# Expedite 5G MIMO Rollouts with Programmable RF Test Devices

One approach being adopted to gain ground in the race to 5G involves the rapid prototyping and testing of network architectures enabled by nimble, self-programmable RF test devices.

**W**hile some companies may be claiming victory in the first heat of the 5G race, it's clear the real winners will most surely come from the middle of the pack. Taking advantage of drafting in the path of telecom giants, these nimbler competitors are making informed decisions and streamlining their approaches.

To make such headway, a number of companies are adopting the approach of rapid prototyping, testing, and deployment of network architectures enabled by nimble, self-programmable RF test devices. With a few of these devices, a laptop, a simple GUI, and a USB cord, designers are quickly confirming or denying various networking and signal management techniques and identifying the best components for their unique signal chains. They're also discovering how to create lower-cost, lighter-weight ATE solutions that can be duplicated, trained, and deployed in various regions.

## MIMO BENEFITING FROM PROGRAMMABLE TESTING DEVICES

The small-cell, millimeter-wave, and massive multiple-input, multiple-output (MIMO) system, currently considered one of the best 5G wireless network approaches, is also one of the most complex. While there's tremendous advantages and efficiencies of a multi-path network, the creation of a test system to perform common simulations, such as fading, becomes exponentially more challenging. This is when many MIMO system designers are enjoying the ability to try subtle tweaks, out-of-the-box ideas, and major rethinks all in one day with the help of their versatile and easily programmed RF test devices.



Lab Bricks developed by Vaunix represent a suite of solid-state programmable RF test devices that include attenuators, signal generators, phase shifters, and switches in various RF/microwave bands.

## HOW DID IT ALL DEVELOP?

So how did self-programmable test devices come to be in wireless telecom? You might say they fell off a bench. The shared test bench of a RF/microwave component and/or sub-system engineering department is typically home to at least one pre-programmed high-frequency benchtop instrument. They're operated by a small screen and front-panel keyboard along with a library of dozens of necessary codes. They're also costly.

Resourceful engineers and test techs at these companies who'd grown tired of getting squeezed for time on the few (if any) full-featured instruments, also recognized the amount of overkill these instruments were when it came to their own unique test or simulation within certain frequency bands. As the burgeoning programmable RF/microwave test device market was taking shape, early evaluations revealed that the approach was not only efficient in the lab, it was even more valuable to a company's techs in the field who were carting around and protecting full-featured pieces of equipment. Once in this team's hands, the programmable trend gained steam.

## EASY CONNECTIVITY AND PROGRAMMABILITY IS KEY

Among the most commonly adopted programmable devices are those featuring driver-less USB HID compatibility.

These devices typically operate from a Windows-based GUI or by tapping into a library of Windows and Linux APIs provided by the manufacturer that support Python, C#, C++, MATLAB, Java, and LabVIEW.

The reason USB HID compatibility appears to be a leading a choice is that it avoids the difficulties inherent in using older serial or IEEE-488 interfaces when implementing over standard USB. As a result, RF/microwave and wireless test system designers don't need to install kernel-level drivers. This makes setup fast, and possible even with low-cost embedded computers like a Raspberry Pi.

### MOBILE WI-FI FOR TRAINS

One application area for attenuators is an ultra-efficient Wi-Fi system for commercial and commuter rail companies. Andrea Oriolo, a Co-founder and VP of Operations of Italian Mobile Wi-Fi specialists at Fluidmesh, used Vaunix's Lab Brick attenuators (*see figure*) in its rail applications. He notes, "The Lab Brick attenuator was really easy to set up. It was truly as simple as plugging in a USB cord and allowing the automated software to load."

Fluidmesh created a radio that used a set of predictive algorithms to keep and hold the best signal strength and bandwidth while simultaneously moving to a second radio before leaving the first in a make-before-break handover. The challenge was then being able to create a simulation of the multitude of nuances that would happen in real time when the radios were deployed on trains.

The company had to contend with a dynamic environment with many transitions—left turns, right turns, moving nearby and far from an antenna—to effectively simulate the roaming of the onboard radio. Meanwhile, simulation also had to consider all of this happening in a crowded environment full of obstacles, such as tall buildings or mountains, that can absorb and reflect signals. Not to mention other moving vehicles and electronic devices that could interfere with signals.

In the past, Fluidmesh's only effective way to simulate this was by manually adjusting the signal strength of the radios while riding the trains themselves and recording the data in real time. This was an arduous and time-consuming exercise that sent its team to the internet to find a better way. They quickly discovered how a portable and easily programmable RF attenuator would allow them to quickly and perfectly attenuate their RF signals and simulate the exact RF signal fading they had observed when the trains moved between various antennas, and among obstacles.

Fluidmesh was able to integrate the attenuators with its existing wireless network ATE system and create the simulated environments and repeatable mobilized scenarios that were needed. The team was able to test network performance theories and adjust their base-station equipment and radios with ease. This reliable simulation also became the key to devel-

oping a new signal transmit/receive algorithm that allowed their technology to mature quickly and speed their integrated, mobile Wi-Fi solution to market.

### CHARACTERISTICS TO LOOK FOR IN SELF-PROGRAMMABLE RF TEST DEVICES

Ready to give programmable wireless testing a try? Keep these things in mind when choosing your preferred vendor:

- **Continuity:** That is, whether you're operating a signal generator, phase shifter, attenuator, or switch singly or together, all adjustments you can make should be performed almost identically. This makes everything from setup through operation far easier than if each user interface (UI) was different.
- **Configurability:** Each time you configure, reconfigure, and control, you should be able to do so from a single interface, rather than through layers and layers of menus.
- **Automatic identification:** Once you connect the device to a laptop or PC, the software should automatically identify it and load the parameters (attenuation, phase, power, and sweep configuration) stored in the device.
- **Intuitive settings:** Any programmable RF test device worth its merit should also allow you to change settings on the fly to see the effect on your device under test (DUT), such as an amplifier on an evaluation board, or an IC, for example.
- **A full suite of bandwidth choices:** Look for companies who can be a resource for test sets across your many possible frequency bands. The adoption of a programmable approach will be quick, so you won't want to source from multiple vendors with different GUIs.
- **Optional high-performance features:** To keep total ATE costs the lowest, look for a manufacturer that has designed both basic devices and more advanced high-performance models, so that you can be assured that you'll only be buying the functions and performance levels you really need.
- **Robust yet portable packaging:** To achieve the reliable and repeatable performance, and the long-term durability required of mobile test systems, look for your portable test devices to be packaged in proven aluminum cast housings. They should also fit in the palm of your hand.
- **Custom capabilities:** Soon after you've hit your stride in configuring and reconfiguring test sets, you're likely to recognize a pattern of common combinations of components. Look for a manufacturer who can integrate these functions into a chassis and deliver the ideal integrated unit for your application. 

---

#### REFERENCES:

<https://vaunix.com/updates/tech-brief-describes-factors-of-testing-and-development-of-your-mimo-systems/>

<https://vaunix.com/updates/fluidmesh-throws-a-lab-brick-at-speeding-trains-to-solve-their-mobilized-wi-fi-handover-testing-challenge/>



# MMIC AMPLIFIERS



**Now!**  
**up to 43.5 GHz**

*Ultra-Wideband, 22 to 43.5 GHz*  
*Excellent Gain Flatness  $\pm 0.9$  dB*  
*Low Noise, 3.5 dB typ.*  
*Built-In Bypass and Shutdown*



(718) 934-4500 sales@minicircuits.com [www.minicircuits.com](http://www.minicircuits.com)



613 Rev Orig\_P

## What's the Difference?

DAVID M. FOSTER | Head of Content, SpeakerChampion  
<https://speakerchampion.com/>

# What's the Difference Between RMS and Peak Watts?

Root mean square (RMS) and peak power ratings are basic power-handling terms. If you're looking to build a high-performance entertainment system, you should understand exactly what they represent.

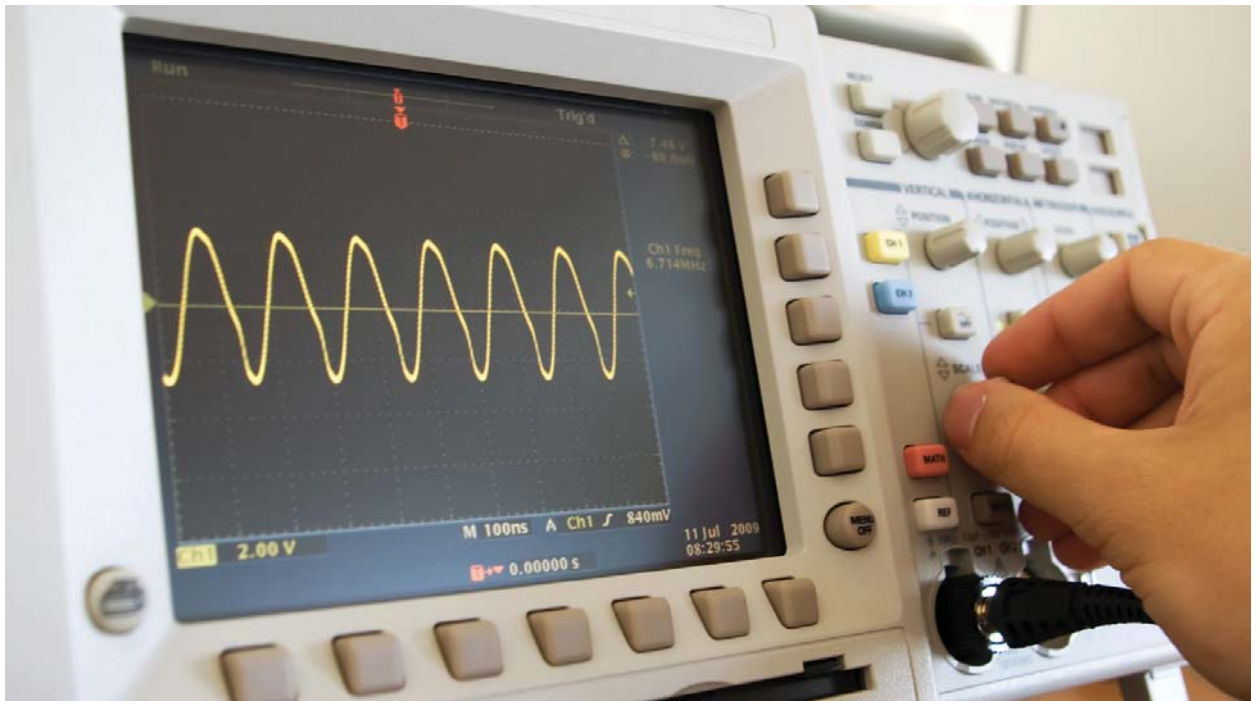

In the consumer electronics world, you will often hear about watts, power handling, and power output. The terms are used interchangeably to refer to two values, that is, root mean square (RMS) and peak power rating. Power rating is among the essential factors that contribute to an ideal sound system. It is, therefore, important to know what these two

values refer to whether you're searching for speakers, amplifiers, or subwoofers.

When looking to build a high-performance entertainment system, most people tend to shop for audio and sound equipment based on the one that has the highest power rating. However, this may prove difficult for starters who don't understand the difference between RMS and peak watts. Also, some may choose

to ignore the ratings and go for brands, but this will affect the final outcome in one way or another.

So, if you're going to spend your hard cash on a surround-sound speaker, subwoofer, or even an amplifier, you'll need to have basic information on power ratings. This comprehensive guide will help you understand these two values to assist in you assembling a decent sound system.

*(Continued on page 47)*

## Components

JAMES PRICE | VP of Engineering, Corry Micronics Inc.  
<https://cormic.com/>

# Stuck in the Middle: How to Choose Your Next Bandpass Filter

The seemingly ubiquitous bandpass filter plays an important role in reducing noise and radiation in an array of applications. Here's a synopsis of the most popular options available.

**B**andpass filters are used in both wired and wireless communications systems, sensor applications, instrumentation, medical applications, and many others. When it comes to these types of applications, the goal is to pass signals of interest from point A to point B, while reducing noise and unwanted radiation from the signal source, other equipment, and the environment. Often different bandpass filters can be combined in a switched filter bank (see figure) that integrate the filters and switches, thereby providing better insertion loss, flatness, VSWR, and overall better performance of the device.

Such filters are used to transmit as well as receive in applications. For example, in a wireless transmit application, the filter is placed between the power amplifier and the antenna, ensuring that amplifier harmonics and out-of-band artifacts are significantly attenuated so that the transmitter does not cause interference with other wireless channels.

Bandpass filters ideally allow signals between a lower frequency and an upper frequency to pass with very little loss, rejecting signals outside the two frequencies' range. The allowed range of frequencies is called the passband.

### BANDPASS-FILTER PERFORMANCE

Filters are often designed with published tables of numbers that are converted into inductors and capacitors to achieve responses, including Chebyshev, Butterworth, Gaussian, and others. Filters can also be synthesized, a process that begins with an equation and results in a network of physical elements.

The object of these exercises is always to determine inductance and capacitance values that achieve the passband and rejection criteria desired. Once the inductance and capacitance elements have been calculated, the theoretical performance of the filter is determined.

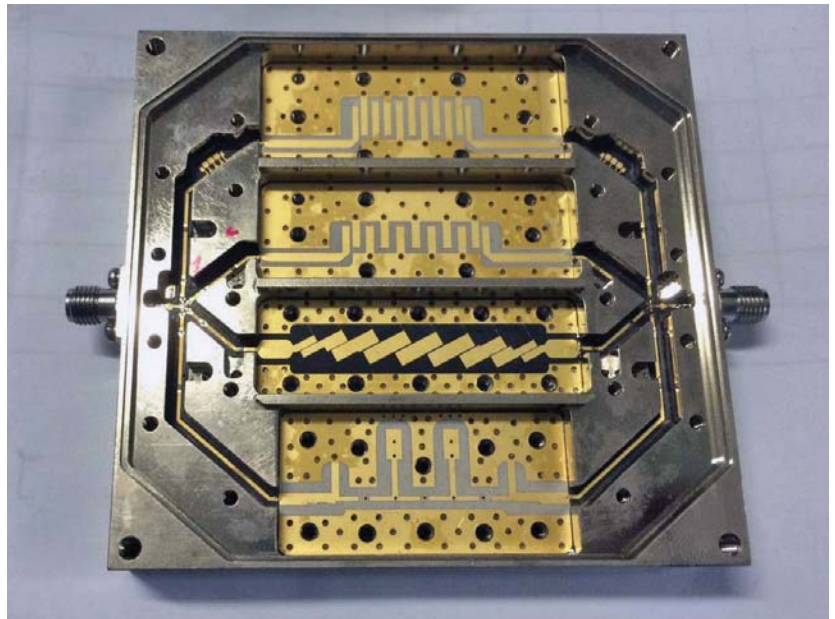

A switched filter bank incorporates multiple bandpass filters in a single package. (Source: Corry Micronics)

### BANDPASS-FILTER CONSTRUCTION

Translating equations and specs to reality is, of course, often a challenge. A bandpass filter must be built so that it can:

- Handle the required power
- Fit within the allotted space
- Meet any other special criteria for its ultimate end use
- Remain on budget

Many different technologies are available for building the filter, and any given set of specifications can dictate a variety of ways of construction. Different filter elements and physical structures all have advantages and disadvantages that can be compared against the specific design criteria for your application.

### CHOOSING THE BEST BANDPASS FILTER FOR YOUR APPLICATION

As with everything in this world, there are advantages, disadvantages, and tradeoffs that need to be considered and accounted for with each approach. So, how do you choose the proper technology for the job? Here's a great example.

Suppose you need a 50-MHz bandwidth bandpass filter centered around 1 GHz and rejection of 50 dB at 200-MHz bandwidth (50-dB rejection at 900 MHz and below and at 1100 MHz and above). After consultation with readily available filter attenuation tables, you decide that a 5-pole filter design will do the job. This filter could be constructed with a variety of distributed or combination approaches, including:

- LC
- Cavity
- Comb
- Stripline, microstrip, or suspended stripline
- Ceramic coaxial
- Helical

All of these filters will achieve the desired passband-rejection response

To further expand the possibilities for their use, inductors and capacitors can be utilized in combination with distributed elements to craft specific performance characteristics. Many filter tables and synthesis tools start out assuming lumped elements are to be employed.

specified. They are all 5-pole filters, and any one of them will work. Ultimately, the choice of which filter type to choose will come down to system requirements and priorities. These priorities could include tradeoffs among insertion loss, power handling, size, weight, temperature stability, ease of construction, cost, and other project parameters. Let's examine the differences between these options.

### UNDERSTANDING THE DIFFERENT TYPES OF BANDPASS FILTERS

#### Lumped-element or LC filters

Lumped-element, or LC, filters provide the desired frequency response using inductors and capacitors (Ls and Cs). LC filters are perhaps the most familiar filter type to most engineers. Many alternatives are available for creating LC filters. Broadly characterized as distributed element filters, they can be made and used in multiple different ways. Distributed filters use transmission lines, short circuits, open circuits, air gaps, and dielectric materials in place of lumped inductors or capacitors.

To further expand the possibilities for their use, inductors and capacitors can be utilized in combination with distributed elements to craft specific performance characteristics. Many filter tables and synthesis tools start out assuming lumped elements are to be employed. Inductors and capacitors are readily available and are an attractive choice for any application already using printed circuit boards.

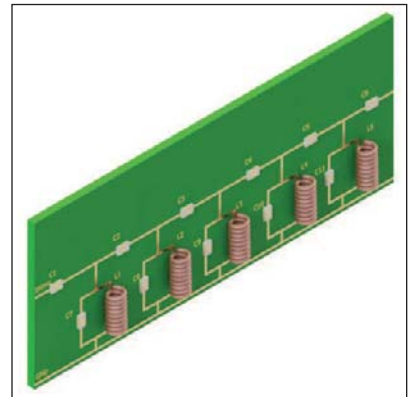

- Insertion loss: Worst
- Filter size: Small
- Power handling: < 10 W
- Typical Q: 50-200
- Cost: Low

#### Cavity and comb filters

Cavity and comb filters both exploit distributed elements. They each use five rods that can be modeled as parallel resonant LC circuits. Each filter is carefully constructed so that the electromagnetic field from one rod couples energy to the next rod to achieve the desired filter bandwidth. For the comb filter, the wider the bandwidth, the closer the rods must be spaced. For the cavity filter, the wider the bandwidth, the larger the openings must be between the rods.

- Insertion loss: Best
- Filter size: Large
- Power handling: 100s of watts +
- Typical Q: 1000-5000
- Cost: High



printed capacitor determines the energy coupled from one resonator to the next. This sets the filter bandwidth. The ceramic coaxial approach shown here is a combination distributed lumped approach as it uses both transmission lines and capacitors.

- Insertion loss: 3rd place
- Filter size: Small
- Power handling: up to 50 W
- Typical Q: 300-600
- Cost: Low to mid-range

### INSERTION LOSS

If insertion loss is an important system parameter, you should consider the possibilities of each filter. Each of these filter types can be analyzed for loss by looking at the quality factor, or “Q” of the elements that make up each filter. The higher the quality factor of the filter elements, the better the insertion loss of the filter.

LC filters are made up of inductors and capacitors, so those are the two Q factors you should consider. Inductor Q is typically much lower than capacitor Q and tends to drive the losses in LC filters. When glancing at datasheets for inductors, you will notice that Q is typically below 200. Ranges of 50 to 100 are actually very common.

Using these numbers as a basis for comparison and knowing the Q values of the other filter technologies, you can infer the relative insertion loss performance.

Note that RC or RL resistor-capacitor- or resistor-inductor-based filters aren’t shown. They’re rarely used due to their increased insertion-loss characteristics.

### FILTER SIZE

Ultimately, if insertion loss is the overriding concern, cavity or comb would be the best filters for you. However, there’s a tradeoff between Q and size, which is the same as a tradeoff between insertion loss and size. Distributed filters get smaller as the frequency increases. So, it’s important to be aware of the relative sizes of the 1-GHz filter our example is considering.

### POWER HANDLING

Any of these filters will work just fine if the power levels going through the filter are relatively low (think just a few watts). If the power level will be on the higher side, you will definitely need to consider that when selecting your band-pass filter.

Among these filter candidates, the best for power transfer are the cavity

### Microstrip filter

Another distributed approach is the microstrip filter. The one shown here is a hairpin design consisting of five u-shaped traces of precise spacing and length.

- Insertion loss: Worst
- Filter size: Medium-small
- Power handling: < 10 W
- Typical Q: 100-200
- Cost: Low to very low

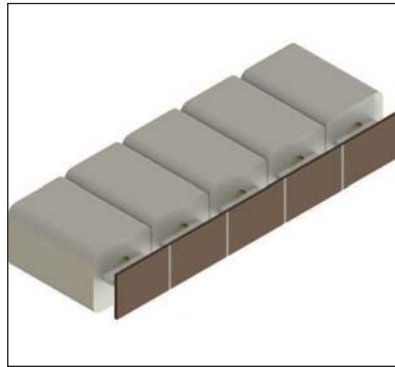

### Helical filter

The helical filter is also a combination of lumped and distributed elements—it uses shorted inductors and electromagnetic coupling from inductor to inductor through air gaps.

- Insertion loss: 2nd place
- Filter size: Medium to large
- Power handling: up to 100 W
- Typical Q: 600-1000
- Cost: High

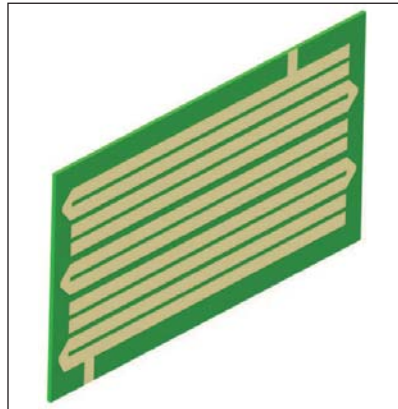

### Ceramic coaxial filter

The ceramic coaxial filter may seem perplexing at first. There are five ceramic resonators, each functioning as a miniature coaxial cable shorted on one end and open on the other. Each shorted resonator acts as a parallel resonant LC circuit just like the cavity and comb filters.

Energy is coupled from one to the other using a silver-plated ceramic plate printed with capacitors. The size of each



If economy is the driving factor in selection, microstrip and LC filters are the best choices. LC filters employ low-cost inductors and capacitors. Microstrip filters don't use any components, but they may be priced slightly higher due to their controlled dielectric laminate. These laminates are generally more expensive than standard FR-4 PCBs.

and comb filters due to their grounded metal enclosures. It's hard to beat a grounded metal enclosure for power handling and heat dissipation. In addition, both cavity and comb filters have the lowest insertion loss. Filter types with higher insertion loss will dissipate more of the signal passing through the filter as heat. Lower Q components have higher resistive losses. Lower insertion loss will improve the power-handling ability of the filter.

**COST**

If economy is the driving factor in selection, microstrip and LC filters are the best choices. LC filters employ low-cost inductors and capacitors. Microstrip filters don't use any components, but they may be priced slightly higher due to their controlled dielectric

laminate. These laminates are generally more expensive than standard FR-4 PCBs. Next would be ceramic coaxial filters followed by helical, comb, and cavity filters, the most expensive options.

**VSWR**

All of these filters can achieve any desired voltage standing-wave ratio (VSWR), but because VSWR is affected by stray capacitance, inductance, and other physical nuances, the best VSWRs are achieved when individual filter characteristics can be adjusted. This is somewhat difficult with LC filters and near impossible with microstrip filters. In the case of LC filters, coils can be knifed, but variable capacitors are impractical most of the time. Similarly, ceramic coaxial resonators have a limited adjustment range.

The candidates for best VSWR performance are the larger filters—the cavity, comb, and helical. These all have built-in tuning adjustments and can achieve excellent VSWR performance by means of “tweaking” these adjustments. **mmw**

**JAMES PRICE** received a BS in Electrical Engineering from West Virginia University, Morgantown, W.V. in 1983. From 1985 to 1995, he was an engineer specializing in communications with RCA, which eventually became Lockheed-Martin in Camden, N.J. From 1995 through 2004, he designed CATV products for Tollgrade Communications, Cheswick, Pa. He's currently VP of Engineering for Corry Micronics in Warrendale, Pa. His areas of focus include RF and microwave filters, multiplexers, switches, and antennas.

## Waveguide Components

OFF THE SHELF FOR CUSTOM DESIGNS



• Attenuators • Couplers • Switches • Loads • Terminations • Adapters • Assemblies • Horns • Ferrite Components

## We're Ready When You Are... Next Day Delivery Of Catalog Components

From The Largest Inventory Of Waveguide Components In The Industry  
**RECTANGULAR, MM-WAVE, & DOUBLE-RIDGED COMPONENTS**

**CUSTOM DESIGNS**

Custom designs are a Waveline specialty. If you don't see the product or design in our catalog, we probably have your “special” in our design files. Waveline now offers a complete line of Pin Diode Switches, Attenuators & Phase Shifters. Waveline has the expertise and capabilities to integrate waveguide and solid-state designs for subassemblies.



CALL OR WRITE

**waveline**®



P.O. Box 718, West Caldwell, NJ 07006  
(973) 226-9100 Fax: 973-226-1565  
E-mail: [wavelineinc.com](mailto:wavelineinc.com)

# From Saving Lives to Leveraging IoT—This Smart Hospital Does It All

The availability of granular real-time data allows this hospital team to gauge how its energy-reduction programs are performing, helping ensure that targets are met on time.

**A**t Maidstone Hospital, a leading hospital in the South East of England, providing general hospital and specialist complex care services to over 600,000 patients simply weren't enough. Armed with an additional initiative to reduce its carbon footprint by 28% (by 2020 from a 2013 baseline) and cognizant on the importance and cost-saving potential of energy conservation, Maidstone set forth to drastically reduce its energy consumption.

The first step in controlling its consumption involved *measurement*—a daunting task as the hospital is a large site, spread over more than 2 million square feet. Though meters were already installed around the facility, only a few were connected to an automated data-collection system that had proven unreliable. In addition, the vast majority of meters had to be manually read, which introduced errors and didn't meet the needs of the on-site energy team. In short, installing cable would be disruptive and expensive.

After exploring numerous options, including using metering that transmits



data using the cellular mobile phone network (which ultimately would be too expensive and only offered data from the past day) the hospital decided to incorporate a solution that leverages the latest long-range, low-power wireless alternative: LoRaWAN.

LoRa, coined from “long range,” is a proprietary spread-spectrum modulation for low-data-rate, low-power, and long-range wireless communication. It's an alternative to other modulations that's tailored for the unique requirements needed by the Internet of Things. LoRaWAN is the wide-area-network protocol specification for use with LoRa modulation and is designed for secure bidirectional communication, mobility, and localization services.

### LoRaWAN SOLUTION

In considering possible solutions, Maidstone ultimately opted to work with Synetica Limited, providers of long-range wireless monitoring solu-

tions for energy, assets, and the environment. Based in the U.K., Synetica's EnLink consists of enLink Modbus, a LoRa wireless Modbus bridge; enLink Pulse, a LoRa wireless Pulse counter; and enLink Zone, a LoRa wireless environmental sensor measuring temperature, humidity, volatile organic compounds (VOCs), and CO<sub>2</sub>.

“The Synetica EnLink system was installed in a short space of time and with almost no disruption,” said Barry Leaf, Estates Manager at Maidstone Hospital. “Installations were carried out in a safe way. The operatives needed a minimum amount of permits to work and certainly no disruptive electrical isolations were required. What's the best news? We now have a valuable insight into our energy consumption.”

Pivotal to the enLink solution is MultiTech's Conduit, a configurable, manageable, and scalable communications gateway for industrial IoT applications. Each Conduit gateway

can manage thousands of LoRaWAN-compliant devices, including MultiTech mDot modules (see figure) and other sensors, as well as transmit their data over any cellular network to a customer's preferred data-management platform.



MultiTech's mDot module uses an Arm Mbed processor to provide LoRaWAN connectivity for M2M applications.

“Our decision to work with MultiTech was based on its compatibility with LoRaWAN and its flexibility to support both cloud-based and on-premise network architectures,” said Sean Williams, Director at Synetica. “MultiTech's IoT gateway is durable enough for the harsh environments we encounter within production sites and is technically advanced and stable. Another factor in our decision was the strong support system in

place and our confidence in knowing that the MultiTech team was working in lockstep with us from the initial stage of proposal through customer implementation and maintenance.”

“We were concerned that our electrical energy requirements throughout our Maidstone Hospital site were not being recorded in a way to allow us to review our loading needs in different locations; the Synetica enLink system allows us to do this,” added Leaf.

The hospital now has real-time data from over 100 meters across the site that allows for an instantaneous measurement of energy impact and carbon reduction. All of this data is provided in fine detail, including the installation of LED lighting and optimizing the heating, ventilation and air conditioning (HVAC) plant and controls across the site. Additional meters were also required to provide in-depth data on the site's consumption.

With the availability of granular real-time data, the hospital team can gauge how its energy reduction programs are performing, which will help ensure that targets are met on time. Ultimately money is saved, allowing more funds and resources for its most important asset—its patients.

**BENEFITS AT A GLANCE**

Benefits derived from EnLink, which incorporated LoRaWAN, included:

- *Ultra-long wireless range:* Made it possible to gather meter data from all areas of the site using just one wireless gateway, without the need for any wireless repeaters.
- *Real-time data:* Data is available in near real-time to support on-the-spot decision making and alerting when excess consumption occurs.
- *Interoperable:* Synetica could link to the existing meters and send the data over the LoRaWAN network.
- *Comprehensive data:* The new meters installed as part of the enLink system provided in-depth information on the electrical performance of the site, not just energy consumption, such as currents, power quality, and power factor.
- *Low cost of ownership:* LoRaWAN wireless is license-free with no ongoing data charges.

“It's been tremendously successful,” added Leaf. “Looking forward, we are considering using the network for other sensing requirements, including legionella monitoring and air-quality measurements. The possibilities are limitless.” **tmw**

## Quad Down Converter for EW, SIGINT, ECM



8.5" x 5.5" x 0.5"

.....Ultra Fast Tuning

**Four Matched Down Converters**

**2-18 GHz / 6-18 GHz**

**1-2 GHz Real Time BW**

**Submicro Tuning Speed**

**High Dynamic Range**

**VPX or Ruggedized Module**

Contact: [sales@fei-elcomtech.com](mailto:sales@fei-elcomtech.com) 201-767-8030 ext 280





## What's the Difference?

(Continued from page 40)

### RMS WATTS EXPLAINED

Root mean square or simply RMS watts refers to continuous power handling of a speaker or a subwoofer or how much continuous power an amplifier can output. RMS values are usually lower than peak watts ratings, but they represent what a unit is truly capable of handling. Think of RMS power as the average power that a speaker can handle on a daily basis without compromising sound quality or experiencing any distortion.

RMS rating, while most use both values. For example, a unit can be rated at 150 W while another brand may be advertised at 75 W.

At first glance, one might be tempted to think that the former is better because it's rated at a higher power level than the latter. However, upon a closer look, you may notice that the first product is rated for peak watts while the second one is advertising RMS watts. Typically, a unit's peak power handling is double the RMS

refer to how much power it can produce for maximum audio performance.

### CONCLUSION

Both RMS and peak watts play an important role in your sound system, and they're vital when comparing your speakers with amplifiers or subwoofers. When matching speakers or subwoofers to amplifiers, you should compare either two RMS values or two peak ratings.

Therefore, one should not get con-

---

**Both RMS and peak watts play an important role in your sound system, and they're vital when comparing your speakers with amplifiers or subwoofers. When matching speakers or subwoofers to amplifiers, you should compare either two RMS values or two peak ratings. Therefore, one should not get confused when comparing peak and RMS ratings.**

---

### PEAK WATTS EXPLAINED

The peak power handling is the highest power level that a speaker or a subwoofer can handle in a short burst without blowing. The same holds for amplifiers as the absolute highest amount of power they can put out before failing or without resulting in distortion.

We can think of peak watts as the number atop of your car's speedometer. For example, you can drive for maybe 180km/h, but you can't sustain that speed for long without causing mechanical or thermal damage to the car. In the same way, the peak power level can only be maintained for a fraction of a second, although there's no clear definition of how long.

If the unit is subjected to constant peak power, the wires may overheat, which could quickly damage the voice coils.

### RMS POWER vs. PEAK POWER

When shopping around, you'll notice that some manufacturers rate their products' power-handling capabilities using either the peak watts rating or

power handling, which basically means that the above products are actually rated the same: 150 W peak/75 W RMS.

Most audio equipment manufacturers, though, prefer to stress more on the peak power rating to make the products look like they deliver more power than they're capable of. While this may sound convincing, utilizing peak power not only disturbs your neighbors, but also makes your sound equipment depreciate in value, requiring you to replace some parts or buy a new unit altogether. As such, if you want your speaker to last for years, the figure to look out for is the RMS wattage, the power input at which you should be enjoying your music.

However, when it comes to these technical details, don't get confused by speaker power ratings and amplifier specifications. Amplifiers generate power in an audio system, which is not the case with speakers and subwoofers. Therefore, speaker power ratings refer to the amount of power your speakers can handle from an amplifier. The specifications on the amp, on the other hand,

fused when comparing peak and RMS ratings. This will ensure that you'll get the best out of each component. If the power outputs aren't correctly matched, the components can overheat and create a couple of other issues. However, it's important to stress that you should always use RMS ratings—not peak wattage—when matching and comparing gear. **mw**

---

**DAVID M. FOSTER** is a passionate sound engineer with over 13 years' experience in the sound industry. He is well-versed with all sound design and engineering aspects, and thus fits the crucial position of Head of Content at SpeakerChampion. He has a degree in Sound Engineering from American River College. Under the leadership of David M Foster, our experienced team of content developers provide extensive sound engineering skills and knowledge. David's expertise ensures that all content is technically correct. His experience has also been instrumental in keeping SpeakerChampion at the forefront of noticing new developments in the sound industry.

## Software

ETHEM SOZER | Principal Software Engineer, MathWorks

HONGLEI CHEN | Principal Software Engineer, MathWorks

MATT SPRAGUE | Software Engineer, MathWorks

SARA JAMES | Software Engineer, MathWorks

RICK GENTILE | Product Manager, MathWorks

# Identify Modulation for Communications and Radar Using Deep Learning

Signals can be extracted automatically using available frameworks and tools, or via alternate approaches, which can then be used to perform modulation classification with a deep-learning network.

**M**odulation identification is an important function for an intelligent receiver. It has numerous applications in cognitive radar, software-defined radio, and efficient spectrum management. To identify both communications and radar waveforms, it's necessary to classify them by modulation type. For this, meaningful features can be input to a classifier.

While effective, this procedure can require extensive effort and domain knowledge to yield an accurate classification. This article will explore a framework to automatically extract time-frequency features from signals. The features can be used to perform modulation classification with a deep-learning network. Alternate techniques to feed signals to a deep-learning network will be reviewed.

To support this workflow, we will also describe a process to generate and label synthetic, channel-impaired waveforms. These generated waveforms will in turn provide the training data that can be used with a range of deep-learning networks. Finally, we will describe how to validate the resulting system with over-

the-air signals from software-defined radios (SDR) and radars.

*Figure 1* shows the workflow, which results in modulation identification and classification.

## CHALLENGES OF MODULATION IDENTIFICATION

Modulation identification is challenging because of the range of waveforms that exist in any given frequency band. In addition to the crowded spectrum, the environment tends to be harsh in terms of propagation conditions and non-cooperative interference sources. When doing modulation identification, many questions arise including:

- How will these signals present themselves to the receiver?
- How should unexpected signals, which haven't been received before, be handled?
- How do the signals interact/interfere with each other?

Machine- and deep-learning techniques can be applied to help with modulation identification. To start, consider the tradeoff between the time required to manually extract features to train a

machine-learning algorithm versus the large data sets required to train a deep-learning network.

Manually extracting features can take time and requires detailed knowledge of the signals. On the other hand, deep-learning networks require large amounts of data for training purposes to ensure the best results. One benefit of using a deep-learning network is that less pre-processing work and manual feature extraction is needed.

With the requirements for perception generally growing for autonomous driving and computer vision, great investments continue to be made on image- and vision-based learning. These investments can be leveraged by other signal-based applications such as radar and communications. This is true whether the data sets include raw data or pre-processed data.

In the examples described below, deep-learning networks perform the "heavy lifting" in terms of classification, so the focus is on the best way to satisfy the data set requirements for training and validation. Data can be generated from fielded systems, but it can be challenging to collect and label this data.

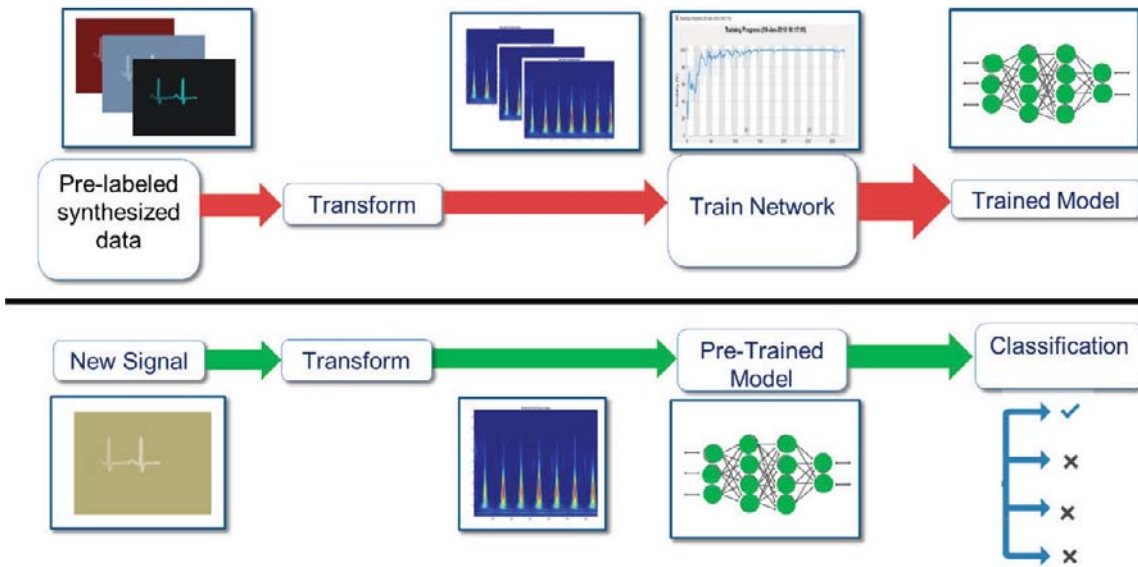

1. This modulation identification workflow with deep learning uses MATLAB. (© 1984–2019 The MathWorks, Inc.)

Keeping track of waveforms and syncing transmit and receive systems results in large data sets that can be difficult to manage. It's also a challenge to coordinate data sources that aren't geographically co-located, including tests that span a wide range of conditions. In addition, labeling this data either as it's collected or after the fact requires much work, because ground truth may not always be available or reliable.

Another option is to use synthetic data, because it can be much easier to generate, manage, and label. The question is whether the fidelity of the synthetic data is sufficient. In the use cases that follow, we will show that generating high-fidelity synthetic data is possible.

### SYNTHESIZING RADAR AND COMMUNICATIONS WAVEFORMS

In our first example, we classify radar and communications waveform types based on synthetic data. As previously noted, the occupied frequency spectrum is crowded and transmitting sources such as communications systems, radio, and navigation systems all compete for spectrum. To create a test scenario, the following waveforms are used:

- Rectangular
- Linear frequency modulation (LFM)
- Barker code
- Gaussian frequency shift keying (GFSK)
- Continuous phase frequency shift keying (CPFSK)
- Broadcast frequency modulation (B-FM)
- Double sideband amplitude modulation (DSB-AM)
- Single sideband amplitude modulation (SSB-AM)

With these waveforms defined, functions are used to programmatically generate 3,000 IQ signals for each modulation type. Each signal has unique parameters and is augmented with various impairments to increase the fidelity of the model. For each waveform, the pulse width and repetition frequency are randomly generated. For LFM waveforms, the sweep bandwidth and direction are randomly generated.

For Barker waveforms, the chip width and number are randomly generated. All signals are impaired with white Gaussian noise. In addition, a frequency offset with a random carrier frequency

is applied to each signal. Finally, each signal is passed through a channel model. In this example, a multipath Rician fading channel is implemented, but other models could be used.

The data is labeled as it's generated in preparation to feed the training network.

### FEATURE EXTRACTION USING TIME-FREQUENCY TECHNIQUES

To improve the classification performance of learning algorithms, a common approach is to input extracted features in place of the original signal data. The features provide a representation of the input data that makes it easier for a classification algorithm to discriminate across the classes.

In practical applications, many signals are nonstationary. This means that their frequency-domain representation changes over time. One useful technique to extract features is the time-frequency transform, which results in an image that can be used as an input to the classification algorithm. The time-frequency transform helps to identify if a particular frequency component or intermittent interference is present in the signal of interest.

Many automated techniques are available for time-frequency transforms, including spectrogram and continuous wavelet transforms (CWT). However, we will use the Wigner-Ville distribution (WVD) because it provides good spectral resolution without leakage effects of other techniques.

The Wigner-Ville distribution represents a time-frequency view of the original data that's useful for time-varying signals. The high resolution and locality in both time and frequency provide good features for the identification of similar modulation types. We compute the smoothed pseudo WVD for each of the modulation types. This is because for signals with multiple frequency components, the WVD performance degrades due to cross terms. The down-sampled images are shown in *Figure 2* for one set of data.

These images are used to train a deep convolutional neural network (CNN). From the data set, the network is trained with 80% of the data and tested on 10%. The remaining 10% is used for validation.

**SET UP AND TRAIN THE DEEP-LEARNING NETWORK**

Before the deep-learning network can be trained, the network architecture must be defined. The results for this example were obtained using transfer learning with AlexNet, which is a deep CNN created for image classification. Transfer learning is the process of retraining an existing neural network to classify new targets. This network accepts image inputs of size 227-by-227-by-3. AlexNet performs classification of 1,000 categories in its default configuration. To tune AlexNet for this data set, we modify the final three classification layers so that they classify only our eight modulation types. This workflow also can be accomplished with other networks such as SqueezeNet.

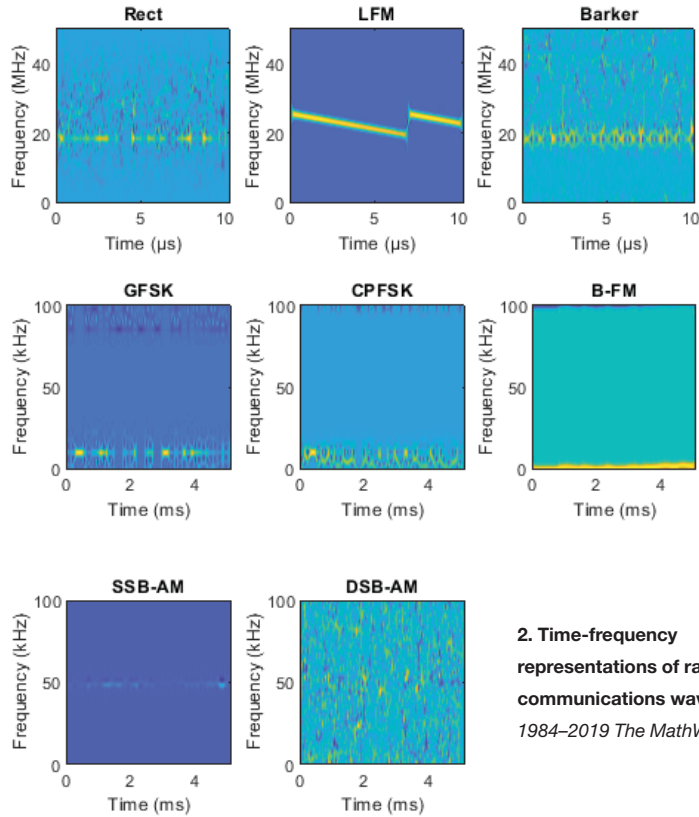

2. Time-frequency representations of radar and communications waveforms. © 1984–2019 The MathWorks, Inc.)

Once the CNN is created, training can begin. Due to the data set's large size, it may be best to accelerate the work with either a GPU or multicore processor. *Figure 3* shows the training progress as a function of time using a GPU to accelerate the training. Training progress is expressed as accuracy as a function of the number of iterations. The validation accuracy is over 97% after epoch 5.

**EVALUATING THE PERFORMANCE**

Recall that we saved 10% of the generated data for testing. For the eight modulation types input to the network, over 99% of B-FM, CPFSK, GFSK, Barker, Rectangular, and LFM modulation types were correctly classified. On average, over 85% of AM signals were correctly identified. From the confusion matrix, a high percentage of DSB-AM signals were misclassified as SSB-AM and SSB-AM as DSB-AM (*Fig. 4*).

The Wigner-Ville distribution represents a time-frequency view of the original data that's useful for time-varying signals. The high resolution and locality in both time and frequency provide good features for the identification of similar modulation types.



3. A GPU is used to accelerate the training process. (© 1984–2019 The MathWorks, Inc.)

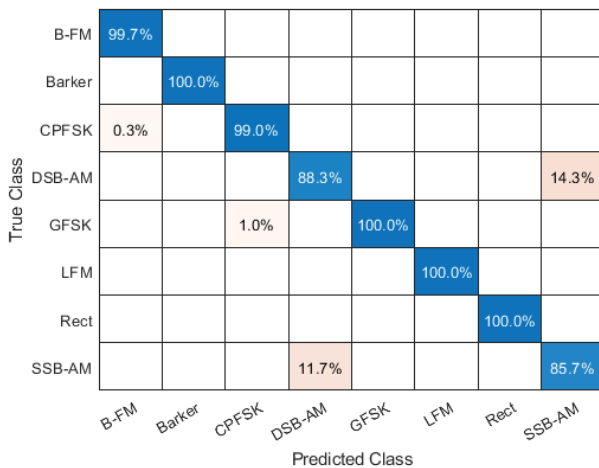

4. The confusion matrix reveals the results of the classification. (© 1984–2019 The MathWorks, Inc.)

The framework for this workflow enables the investigation of the misclassifications to gain insight into the network’s learning process. Since DSB-AM and SSB-AM signals have a very similar signature, this explains in part the network’s difficulty in correctly classifying these two types. Further signal processing such as the CWT could make the differences between these two modulation types clearer to the network and result in improved classification. Specifically, the CWT offers better multi-resolution analysis, which provides the network with better information related to abrupt changes in the frequency of the signals.

This example showed how radar and communications modulation types can be classified by using time-frequency signal-processing techniques and a deep-learning network. In the second example, we will look at other techniques to input data into the network. Furthermore, we will use data from a radio for the test phase.

#### ALTERNATE APPROACHES

For our second approach, we generate a different data set to work with. The data set includes the following 11 modulation types (eight digital and three analog):

- Binary phase-shift keying (BPSK)
- Quadrature phase-shift keying



5. The distribution of labeled data is set by waveform type. (© 1984–2019 The MathWorks, Inc.)

- (QPSK)
- 8-ary phase-shift keying (8-PSK)
- 16-ary quadrature amplitude modulation (16-QAM)
- 64-ary quadrature amplitude modulation (64-QAM)
- 4-ary pulse amplitude modulation (PAM4)
- Gaussian frequency-shift keying (GFSK)
- Continuous phase frequency-shift keying (CPFSK)
- Broadcast FM (B-FM)
- Double-sideband amplitude modulation (DSB-AM)
- Single-sideband amplitude modulation (SSB-AM)

## Modulation Identification

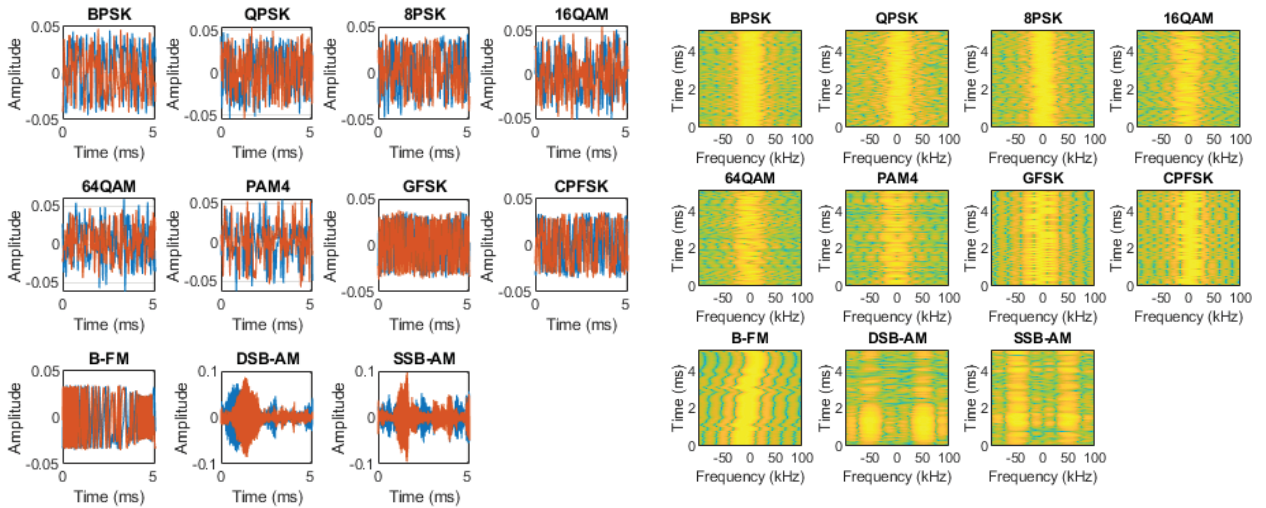

6. Shown are examples of time representation of generated waveforms (left) and corresponding time-frequency representations (right).

(© 1984–2019 The MathWorks, Inc.)

In this example, we generate 10,000 frames for each modulation type. Again, 80% of the data is used for training, 10% is used for validation, and 10% is used for testing as shown in Figure 5.

For digital modulation types, eight samples are used to represent a symbol. The network makes each decision based on single frames rather than on multiple consecutive frames. Similar to our first example, each signal is passed through a channel with additive white Gaussian noise (AWGN), Rician multipath fading, and a random clock offset. We then generate channel-impaired frames for each modulation type and store the frames with their corresponding labels.

To make the scenario more realistic, a random number of samples are removed from the beginning of each frame to remove transients and to make sure that the frames have a random starting point with respect to the symbol boundaries. The time and time-frequency representations of each waveform type are shown in Figure 6.

7. Results with I/Q components are represented as rows (top) and as pages (bottom). (© 1984–2019 The MathWorks, Inc.)

**Confusion Matrix for Test Data**

True Class \ Predicted Class	16QAM	64QAM	8PSK	B-FM	BPSK	CPFSK	DSB-AM	GFSK	PAM4	QPSK	SSB-AM	Accuracy	Confusion
16QAM	862	103	20							4	11	86.2%	13.8%
64QAM	493	499	4							2	2	49.9%	50.1%
8PSK	4		897		1					1	97	89.7%	10.3%
B-FM				999						1		99.9%	0.1%
BPSK			1		999							99.9%	0.1%
CPFSK						1000						100.0%	
DSB-AM							952				48	95.2%	4.8%
GFSK								1000				100.0%	
PAM4	3	2			1				993	1		99.3%	0.7%
QPSK	5		161							834		83.4%	16.6%
SSB-AM							64				936	93.6%	6.4%

**Confusion Matrix for Test Data**

True Class \ Predicted Class	16QAM	64QAM	8PSK	B-FM	BPSK	CPFSK	DSB-AM	GFSK	PAM4	QPSK	SSB-AM	Accuracy	Confusion
16QAM	867	124	7							2		86.7%	13.3%
64QAM	182	814	1							2	1	81.4%	18.6%
8PSK	3	2	957		1						37	95.7%	4.3%
B-FM				999								99.9%	0.1%
BPSK					1000							100.0%	
CPFSK				1		999						99.9%	0.1%
DSB-AM							946				54	94.6%	5.4%
GFSK								1000				100.0%	
PAM4		1							999			99.9%	0.1%
QPSK	1		43							956		95.6%	4.4%
SSB-AM							59				941	94.1%	5.9%



8. The SDR configuration uses ADALM-PLUTO radios (left). Also shown is a corresponding confusion matrix (right). (© 1984–2019 The MathWorks, Inc.)

**Confusion Matrix for Test Data**

True Class \ Predicted Class	16QAM	64QAM	8PSK	B-FM	BPSK	CPFSK	GFSK	PAM4	QPSK	Accuracy	Miss Rate
16QAM	99	1								99.0%	1.0%
64QAM	7	93								93.0%	7.0%
8PSK			100							100.0%	
B-FM				98				2		98.0%	2.0%
BPSK					100					100.0%	
CPFSK						100				100.0%	
GFSK							100			100.0%	
PAM4								100		100.0%	
QPSK									100	100.0%	

## TRAIN THE CNN AND EVALUATE THE RESULTS

For this example, a CNN that consists of six convolution layers and one fully connected layer is used. Each convolution layer except the last is followed by a batch normalization layer, rectified-linear-unit (ReLU) activation layer, and max pooling layer. In the last convolution layer, the max pooling layer is replaced with an average pooling layer. To train the network, a GPU is used to accelerate the process.

In the previous example, we transformed each of the signals to an image. For this example, we look at an alternate approach where the I/Q baseband samples are used directly without further preprocessing.

To do this, we can use the I/Q baseband samples in rows as part of a 2D array. In this case, the convolutional layers process in-phase and quadrature components independently. Only in the fully connected layer is information from the in-phase and quadrature components combined. This yields a 90% accuracy.

A variant on this approach is to use the I/Q samples as a 3D array where the in-phase and quadrature components are part of the third dimension (pages). This approach mixes the information

Frameworks and tools exist to automatically extract time-frequency features from signals. These features can be used to perform modulation classification with a deep-learning network.

in the I and Q evenly in the convolutional layers and makes better use of the phase information. The variant yields a result with more than 95% accuracy. Representing I/Q components as pages instead of rows can improve the network's accuracy by about 5%.

As the confusion matrix in *Figure 7* shows, representing I/Q components as pages instead of rows dramatically increases the ability of the network to accurately differentiate 16-QAM and 64-QAM frames and QPSK and 8-PSK frames.

## TESTING WITH SDR

In the first example we described (with radar and communications signals), we tested the trained network using only synthesized data. For the second example, we use over-the-air signals generated from two ADALM-PLUTO radios that are stationary and configured on a desktop (*Fig. 8*). The network achieves 99% overall accuracy. This is better than the results obtained for synthetic data because of the simple configuration. In addition, the workflow can be extended for radar and radio data collected in more realistic scenarios.

## SUMMARY

Frameworks and tools exist to automatically extract time-frequency features from signals. These features can be used to perform modulation classification with a deep-learning network. Alternate techniques to feed signals to a deep-learning network are also possible.

It's possible to generate and label synthetic, channel-impaired waveforms that can augment or replace live data for training purposes. These types of systems can be validated with over-the-air signals from software-defined radios and radars. **mw**

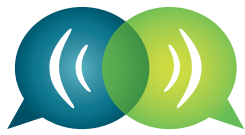

# IMS

Connecting Minds. Exchanging Ideas.



## HOW DOES CONNECTIVITY MATTER TO YOU?

# 10,000

Attendees from 48 Countries of which 37% are First-Time Attendees!



Over **625** Exhibiting Companies

including **10%** First-Time Exhibitors!

# 20%

of Attendees are Senior Management



# 33%

of Attendees are Design Engineers or Engineering Management



# 11%

of Attendees are in Research and Development

5G

Dedicated tracks on 5G, Autonomous vehicles and Aerospace



Discover New Solutions and Gain Valuable Insights

Countless Networking Opportunities



### Can't Miss Event for the RF & Microwave Industry!

REGISTER TODAY!



# www.ims-ieee.org

21-26 June 2020





## New Products

### Latest 12G MCX Connectors Boost Frequency Capability

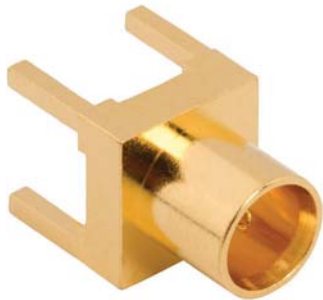

**THE NEWEST MEMBER** in Amphenol's 12G line is an enhanced 75-Ω MCX connector. The connectors can support data rates up to 12 Gb/s and are marketed toward the 4K and Ultra HD broadcast applications. However, the connectors can be used wherever a high-speed signal connection is needed. Operating frequency range includes dc through 12 GHz with a spec'd return loss of 20 dB up to 6 GHz and 15 dB guaranteed up to 12 GHz. The connectors are rated to operate over temperature ranges from -65 to +165°C. Although MCX connectors are larger than MMCX and lower-profile options such as IPEX, they offer a more rigid and durable connection for cables.

**AMPHENOL CORP.**, 358 Hall Ave., Wallingford, CT 06492; (203) 265-8900; [www.amphenol.com](http://www.amphenol.com)

### BPSK Transmitter Module Supports 600- to 9,600-Bit/s Data Rates

**THE CMX7146 FROM CML MICROCIRCUITS** is an integrated Tx module for use with binary phase-shift keying (BPSK) and differential BPSK modulation systems. The chip is able to generate in-phase and quadrature baseband signal outputs, which can then be used by the designer to upconvert to an RF carrier frequency most suitable for the application. Data rates supported include 600/1200/2400/3600/4800/9600 bits/s. The data input supports raw bits as well as preloaded messages with a transmit trigger for precise transmit timing options. A power-amplifier ramping DAC also can be used to create transmission bursts with up to 13 bytes per burst. The part comes in a 48-pin QFN package and is configured through an SPI interface. Furthermore, it is low power, consuming 7 mA with a 1200-bit/s data output and 15 mA with a 9600-bit/s output.

**CML MICROCIRCUITS LTD.**, Oval Park, Langford, Maldon, Essex, CM9 6WG, England; phone: +44 (0)1621 875500; [www.cmlmicro.com](http://www.cmlmicro.com)

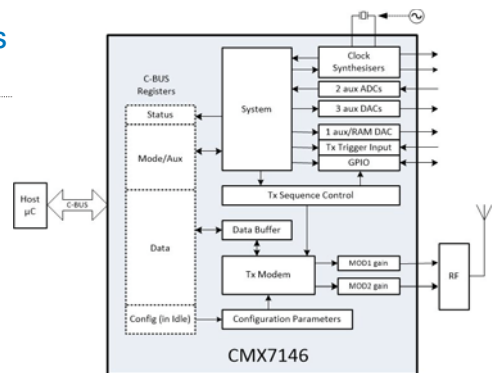

### Interference Generator Delivers LBT Test for LoRaWAN



**THE LATEST TEST EQUIPMENT** coming from RedwoodComm includes an interference generator for Listen Before Talk (LBT) features for LoRaWAN. LBT is important to provide reliable communication links between devices and prevent collisions and interference from devices communicating in the same frequency bands. In general, devices will enter an Rx mode to determine if signals are present before trying to communicate on channels. The RWC2020A allows for testing of LBT by generating up to eight interfering CW signals with high spectral quality. In addition, two tones of up 20-MHz separation can be generated for

intermodulation immunity testing. Frequency coverage is available from 400 to 1000 MHz with a resolution of 100 Hz. Furthermore, output level can be varied from -100 to -10 dBm with ±1 dB of accuracy. Single-tone phase noise is listed as: -103 dBc @ 1 kHz; -110 dBc @ 10 kHz; -110 dBc @ 100 kHz; and -138 dBc @ 1 MHz.

**REDWOODCOMM**, #14008, Section, SK M-City Tower, 195, Baengma-ro, Ilsandong-gu, Goyang-si, Gyeonggi-do, Korea; phone: +82-70-7727-7011; [www.redwoodcomm.com](http://www.redwoodcomm.com)

ADVERTISER	PAGE
<b>3</b>	
3H COMMUNICATION SYSTEMS.....	21
<i>www.3HCommunicationSystems.com</i>	
<b>A</b>	
AMCOM.....	1
<i>www.amcomusa.com</i>	
ANRITSU COMPANY .....	C2
<i>www.anritsu.com/test-measurement</i>	
AVTECH ELECTROSYSTEMS LTD. ....	4
<i>www.avtechpulse.com</i>	
<b>C</b>	
CIAO WIRELESS INC.....	7
<i>www.ciaowireless.com</i>	
COILCRAFT .....	C4
<i>www.coilcraft.com</i>	
<b>D</b>	
DBM CORP, INC. ....	C3
<i>www.dbmcorp.com</i>	
<b>F</b>	
FAIRVIEW MICROWAVE.....	16
<i>www.fairviewmicrowave.com</i>	
FEI-ELCOM TECH, INC. ....	46
<i>www.fei-elcomtech.com</i>	
<b>H</b>	
HEROTEK INC.....	5
<i>www.herotek.com</i>	
<b>I</b>	
IMS.....	54
<i>www.ims-ieee.org</i>	

Subscription Assistance and Information:  
(ISSN 0745-2993)

Microwaves & RF is published monthly. Microwaves & RF is sent free to individuals actively engaged in high-frequency electronics engineering. In addition, paid subscriptions are available. Subscription rates for U.S. are \$95 for 1 year (\$120 in Canada, \$150 for International). Published by Endeavor Business Media, 9800 Metcalf Ave., Overland Park, KS 66212-2216. Periodicals Postage Paid at Kansas City, MO and additional mailing offices. POSTMASTER: Send change of address to Microwaves & RF, PO Box 3257, Northbrook, IL 60065-3257. For paid subscription information, please contact Microwaves & RF at PO Box 3257, Northbrook, IL 60065-3257. Canadian GST #R126431964.

ADVERTISER	PAGE
<b>I</b>	
IRONWOOD ELECTRONICS INC.....	34
<i>www.ironwoodelectronics.com</i>	
<b>K</b>	
KOAXIS INC .....	15
<i>www.koaxis.com</i>	
<b>M</b>	
MICRO LAMBDA WIRELESS, INC.....	9
<i>www.microlambdawireless.com</i>	
MINI-CIRCUITS/SCI COMPONENTS.....	11, 27, 30-31, 33, 39
<i>www.minicircuits.com</i>	
<b>N</b>	
NI AWR CORPORATION .....	2
<i>www.awrcorp.com/smarterdesign</i>	
<b>P</b>	
PASTERNAK .....	C1, 12, 13
<i>www.pasternack.com</i>	
POLYFET RF DEVICES .....	34
<i>www.polyfet.com</i>	
<b>W</b>	
WAVELINE INC.....	44
<i>www.wavelineinc.com</i>	

*This index is provided as an additional service by the publisher, who assumes no responsibility for errors or omissions.*

Back issues of MicroWaves and Microwaves & RF are available on microfilm and can be purchased from National Archive Publishing Company (NAPC). For more information, call NAPC at 734-302-6500 or 800-420-NAPC (6272) x 6578. Copying: Permission is granted to users registered with the Copyright Clearance Center, Inc. (CCC) to photocopy any article, with the exception of those for which separate copyright ownership is indicated on the first page of the article, provided that a base fee of \$1.25 per copy of the article plus 60 cents per page is paid directly to the CCC, 222 Rosewood Dr., Danvers, MA 01923. (Code 0745-2993/02 \$1.25 +.60) Copying done for other than personal or internal reference use without the expressed permission of Endeavor Business Media, is prohibited. Requests for special permission or bulk orders should be addressed in writing to the publisher. Copyright 2020 • Endeavor Business Media • All rights reserved. Printed in the U.S.

# Ultra high bandwidth Payload & RF Multipath Link Emulator

Just released ...

Sophisticated high bandwidth (up to 600MHz) emulation of physical layer RF link effects channel modeling (delay, Doppler, AWGN, Multipath) and hardware in the loop impairments modeling (programmable Group delay, Phase noise, gain/compression distortion and non-linearity AM/AM, AM/PM simulation etc.

Comprehensive range of instruments from 72 MHz to 600 MHz bandwidth with a wide RF frequency tuning range.

Contact dBm for specifications, pricing information and demonstration/evaluation units.



- ◆ **RF physical layer Link emulation**
- ◆ **Point to Point UHF/VHF radio testing**
- ◆ **Real time control for Aerial Vehicle (UAV) testing**
- ◆ **Payload and ground station emulation**
- ◆ **Multipath, 12 paths @ 600MHz BW**

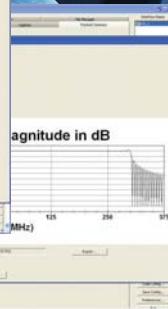
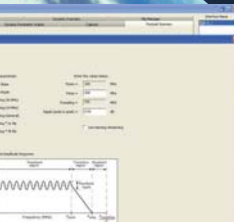
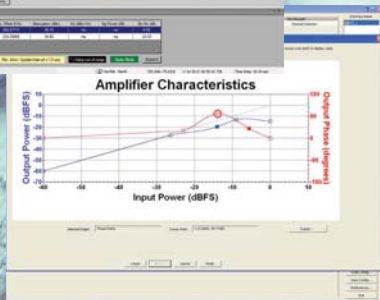

RF Test Equipment for Wireless Communications

email: [info@dbmcorp.com](mailto:info@dbmcorp.com)

dBm Corp, Inc

32A Spruce Street ◆ Oakland, NJ 07436  
Tel (201) 677-0008 ◆ Fax (201) 677-9444

[www.dbmcorp.com](http://www.dbmcorp.com)

# Matchmaker



*0402DC Series Designer's Kit (C472-2):  
20 samples each of 112 inductance values,  
including 0.1 nH increments from 2.8 nH to 10 nH*

**Looking for the perfect high-Q inductor for impedance matching in RF/microwave antenna circuits? This kit has it!**

Coilcraft 0402DC Series wirewound chip inductors offer the industry's highest Q factors in an 0402 (1005) size for super low loss in high frequency circuits. And with 112 values from 0.8 to 120 nH, including **0.1 nH increments from 2.8 nH to 10 nH**, you'll have exactly what you need for all your RF and Microwave applications.

The 0402DC also features wirewound

construction for extremely high self resonance – up to 28.8 GHz – and offers DCR as low as 25 m $\Omega$ , significantly lower than other inductors this size.

Equip your lab with the ultimate impedance matching resource. Our C472-2 Designer's Kit has 20 samples of all 112 values! Purchase one online at [www.coilcraft.com/0402DC](http://www.coilcraft.com/0402DC).



[WWW.COILCRAFT.COM](http://WWW.COILCRAFT.COM)

